

A guide for identifying the reuse potential of construction products

Working Draft version, 29 March 2020



Authors

Morgane Deweerdt (BBRI) & Marilyn Mertens (Brussels Environment)

In collaboration with:

Jeroen Vrijders (BBRI), Florence Poncelet (BBRI), Corinne Bernair (Brussels Environment), Nicolas Scherrier (Brussels Environment), Hugo Topalov (Bellastock), Mathilde Billet (Bellastock), Lara Perez-Dueñas (Construction Confederation), Petra Ronda (Construction Confederation), Jonathan Boulvain (Construction Confederation), Sylvain Laurenceau (CSTB), Marion Lopez (CSTB), Frédéric Bougrain (CSTB), Mathilde Doutreleau (CSTB), Thornton Kay (Salvo), Becky Moles (Salvo), Sara Morel (Salvo), Faye Thorley (Salvo), Michael Ghyoot (Rotor), Pierre-Yves Volont (Rotor), Sophie Boone (Rotor), Léa Bottani-Dechaud (Rotor), Duncan Baker-Brown (UoB), Siobhan O'Dowd (UoB), Ambroise Romnée.

Contact Person:

Morgane Deweerdt (BBRI)
morgane.deweerdt@bbri.be

Marilyn Mertens (Bruxelles Environnement)
mmertens@environnement.brussels

This manual has been produced as part of the project Interreg NWE 739: Facilitating the Circulation of Reclaimed Building Elements (FCRBE), October 2018-January 2022.

The FCRBE project aims to increase the amount of reclaimed building elements in circulation within its territory by +50% (in mass) by 2032.

This draft manual has been developed as part of one of the three thematic work packages of the FCRBE project, which aims to foster the reclamation of reusable building elements from the building stock. The document corresponds to Deliverable 1.2 of Activity 1 of the Work Package 2 (WP T2).

<http://www.nweurope.eu/fcrbe>

This working draft is not the final version. An expected output of this work package is the delivery of an updated version after the present method has been tested and promoted through pilot operations.

This document benefited from the support of the European Regional Development Fund through the Interreg NWE program.



The FCRBE project is a partnership between Bellastock, the Belgian Building Research Institute, Brussels Environment, Centre Scientifique et Technique du Bâtiment, the Construction Confederation, Rotor, Salvo and the University of Brighton.

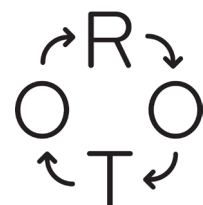

Table of content

INTRODUCTION	6
Why reuse building products?	7
From demolition to reclamation	7
1. WHEN SHOULD YOU CONDUCT A RECLAMATION AUDIT?	8
Asbestos survey	10
Taking advantage of planning	11
Pre-demolition waste audit	11
2. WHO CAN CONDUCT A RECLAMATION AUDIT?	14
Architects	16
Building owners	16
Construction controllers	17
Construction and demolition contractors	17
Reclamation dealers	17
Reuse experts	18
3. WHICH REUSE DESTINATIONS?	20
The reclamation market	22
A specific project	24
Other channels	24
4. HOW AMBITIONS DEFINE THE TYPE OF APPROACH?	26
Defining the ambitions and the scope of the audit	29
Principal audit approaches	30
5. HOW DO YOU CONDUCT THE RECLAMATION AUDIT?	32
5.1. Introduction to the process	34
5.2. How to identify potentially reusable products in an existing building?	36
5.2.1. Proceeding by analogy: commonly reclaimed construction products	36
5.2.2. Following general criteria	37
5.3 What information should be collected and how should it be collected in an inventory?	41
5.3.1. The right state of mind	41
5.3.2. Template 1 – Primary information (see Annex 2 – sheet 1)	42
5.3.3. Template 2 – Complementary information (see Annex 2 – sheet 2)	46
5.3.4. Level of detail	53
5.4 What's next?	57
ANNEXES	60
Annex 1 – Glossary	62
Annex 2 – Templates	65
Annex 3 – Commonly reclaimed construction products	69
Annex 4 – Examples of reuse operations	80
Annex 5 – How to take reclamation pictures	89
Annex 6 – Hazardous substances	97
Annex 7 – Further reading	101

Introduction

This document offers guidelines on conducting a reclamation audit.

A reclamation audit is an operation carried out in buildings scheduled for partial or total demolition. It aims at identifying the building materials and products presenting a high reuse potential. This audit results in a 'reclamation inventory', listing the identified reusable building elements. The resulting inventories present information on the materials' and products' characteristics such as dimensions, quantities, conditions, environmental impact, technical characteristics, disassembly recommendations, etc.

Reclamation audits are a crucial step towards enhancing the amount of building materials and products being effectively reused by the construction industry. In regard to this general objective, reclamation inventories can serve different purposes:

- Providing building owners and designers of new projects with information on same-site reuse opportunities.
- Advertising the availability of potentially reusable materials to reclamation professionals and other interested parties who will contribute to the effective circulation of the elements.
- Indicating which elements need to be carefully dismantled to the demolition contractor.
- Serving as a decision tool for discussing the effective reclamation and the destination of the products.

This manual presents a method on how to conduct these audits.

It addresses building professionals and any stakeholders involved in the (de)construction process: building owners, contractors, architects and engineers, etc.

The text body provides guidance on the most frequently asked questions: When should a reclamation audit be conducted and by whom? How can it be combined with other pre-demolition audits? How do you assess the 'reuse potential' of a building material? How do you conduct it? What important information should be collected and how should it be structured? When completed, how should the inventory be used?

The manual also includes some annexes, providing practical information, examples and tutorials.

Why reuse building products?

Many drivers can motivate reuse in the current practices of the construction industry.

1. Reuse lowers the environmental impact of the construction industry.

Reclaiming building materials and products prevents impacts related to the manufacturing of new products. The impact of using, for the same requirement, reused building materials can be 2 to 12 lower than new equivalents, Life Cycle Analysis demonstrates. Integrating reclaimed building products is thus an effective way to significantly lower the environmental impact of building development. Keeping building elements in circulation by reusing them also reduces the amount of construction and demolition waste (C&D waste). By extension, it bypasses the impacts related to waste treatment strategies (recycling, incineration and land filling).

Future frameworks and new regulations will increase the demand for products with a lower environmental impact, notably in terms of CO₂ production or depletion of non-renewable resources.

Reusing building products is an effective way to meet these requirements.

2. Reuse stimulates interesting economies.

The reclamation of building materials and products presents a high potential for developing the local economy. Many operations are required to keep a building element in circulation, such as identification, dismantling, cleaning, sorting, documenting, stockholding and shipping. These labour-intensive steps can be undertaken by a network of local SMEs.

Nowadays, it is estimated that less than 1% of the materials disposed of as waste during a construction or a demolition are effectively reused. The existing reclamation trade presents a potential for expansion, not only in terms of volumes processed but also in the range of building materials being reclaimed. This offers opportunities to develop new local jobs.

3. Reuse preserves cultural values embedded in the existing buildings and their components.

Reuse involves the acknowledgement of the material and immaterial heritage present in the built environment.

From demolition to reclamation

When a building is scheduled for demolition, the first step to a more sustainable approach is to ask whether part of it could be preserved. If keeping the building (or some parts of it) in place is not an option, reusing its components should be considered.

In this regard, conducting a reclamation audit is the very first step in assessing if a building contains elements with a reuse potential, and to organise their subsequent reclamation.

1. When should you conduct a reclamation audit?

1. When should you conduct a reclamation audit?

Before being demolished (or transformed), a building is usually subject to different assessments: real-estate appraisal, inventory of hazardous substances, pre-demolition audit, etc. Assessing the reuse potential of building elements and materials is yet another type of analysis. This assessment can be conducted at different times, depending on the planning, context and objectives of the project.

The following considerations should help a building owner or an expert to opt for the best option in their respective situation.

Asbestos survey

In many contexts (mandatory in Belgium¹ and France² and required by the CDM regulations in the UK³), an asbestos survey is required when a demolition or renovation is expected.

This specific audit requires the intervention of an authorised expert.

Such a survey is very useful for most of the subsequent operations and thus preferably performed as early as possible. It provides useful information with respect to the reuse potential. Safe materials can be identified, while others might be excluded from reuse. In some cases, the presence of asbestos will complicate the reclamation of reusable construction products or will require specific precautions (if a component has to be salvaged which is close to a source of asbestos, for instance⁴).

- It is recommended that the reclamation audit is conducted after the asbestos survey.
- In any case, no dismantling operation or destructive test should be carried out without an assessment on the presence of asbestos (although a reclamation auditor could still make a preliminary visual assessment of the reuse potential).

1 10 april 2008 - Arrêté du Gouvernement de la Région de Bruxelles-Capitale relatif aux conditions applicables aux chantiers d'enlèvement et d'encapsulation d'amiante,

http://www.ejustice.just.fgov.be/cgi_loi/change_lg.pl?language=fr&la=F&table_name=loi&cn=2008041040

17 July 2003 - Arrêté du Gouvernement wallon déterminant les conditions intégrales relatives aux chantiers d'enlèvement et de décontamination de bâtiments ou d'ouvrages d'art contenant de l'amiante et aux chantiers d'encapsulation de l'amiante (M.B. 17/10/2003 - err. 11/05/2004), <http://environnement.wallonie.be/legis/pe/peintegr008.htm>

29 March 2019. - Décret modifiant diverses dispositions du titre X du décret du 5 avril 1995 contenant des dispositions générales concernant la politique de l'environnement et le décret du 23 décembre 2011 relatif à la gestion durable de cycles de matériaux et de déchets http://www.ejustice.just.fgov.be/cgi_loi/change_lg.pl?language=fr&la=F&cn=2019032923&table_name=loi

2 16 July 2019 - Arrêté du 16 juillet 2019 relatif au repérage de l'amiante avant certaines opérations réalisées dans les immeubles bâtis, JORF n°0165 du 18 juillet 2019

texte n° 34, <https://www.legifrance.gouv.fr/affichTexte.do?cidTexte=JORFTEXT000038777498&categorieLien=id>

3 <https://www.darleypcm.com/blog/cdm/cdmregulationexplainedwhatsurveysneedtobecommissioned>

4 For more information, see Annex 6

Taking advantage of planning

The actual reclamation operations can take place during different phases. For some elements, they need to be coordinated with the demolition works (for salvaging a structural beam, for instance). For other elements, however, they can occur earlier and independently. In some cases, the building owner may take advantage of the waiting period before getting the demolition permit to set up an initial phase of reclamation operations (for interior elements, for example). Anticipation is usually key to maximising reclamation.

→ Therefore, the reclamation audit should start as early as possible, to plan the dismantling phases as efficiently as possible.

(Pre-demolition) waste audit

In some contexts, building owners must establish a pre-demolition waste audit (either requested by a specific regulation or on a voluntary basis⁵). The aim of such an audit is to predict the nature and quantity of the materials that are released from the demolition and to define their destination: reuse, recycling, energy recovery or disposal. This audit provides better waste management.

In Belgium, an important objective of this audit is dedicated to the identification of hazardous substances (including asbestos) via destructive tests which implies that the building is already empty.

It seems logical to combine the waste audit with the reclamation audit. European guidelines explicitly propose proceeding in this manner⁶. And in some cases, this approach will indeed be perfectly valid.

Merging these audits can help to provide a complete overview of the planning for the demolition and dismantling phases and supports the development of a more general circular strategy.

However, there are a few elements to consider when assessing the opportunity resulting from combining these two approaches:

- **Timing.** Both the audits should be carried out well in advance, before the actual works begin, to secure a solid waste and reuse management plan.
- **Categories and metrics.** Waste audits are structured in relation to waste categories. Most of the time, they refer to Eural codes, a European classification of waste categories which is structured according to a material-based approach⁷. However, in most cases, reclaimed construction products do not fit within these categories. Many components are hybrid. For instance, in a classical waste audit, a window would be counted as contributing to producing a certain amount of glass, on the one hand, and

5 Cf. *Review of existing pre-demolition tools, policies, resources for identifying, quantifying and organising the reclamation of reusable elements*, https://www.nweurope.eu/media/8917/fcrbe_wpt2_d11_20190927-for-publication.pdf

6 European Commission, Directorate-General for Internal market, Industry, Entrepreneurship and SMEs. *Guidelines for the waste audits before demolition and renovation works of buildings. EU Construction and Demolition Waste Management*. May 2018. Available online: https://ec.europa.eu/docsroom/documents/31521/attachments/1/translations/en/renditions/native_

7 <https://www.ovam.be/eural-de-europese-afvalstoffenlijst>

a certain amount of wood (or aluminium or PVC) on the other. In a reclamation audit, the same window, kept intact, would be counted as one element.

- **Expertise.** In the current situation, experts in charge of conducting waste audits are usually not very familiar with reuse and reclamation processes. They are not trained to spot reuse opportunities. The risk of missing interesting opportunities can be mitigated by allowing these experts to team up with reuse specialists or by letting them become specialists.
 - **Waste versus product.** If the holder clearly expresses their wish that elements be reused, it is already helping to prevent these goods from being considered and treated as waste. This confirms that great care should be taken to distinguish between potentially reusable elements and the rest of the waste flow.
- Combining reuse and waste audits is a viable option if the main differences between these two approaches are considered.
- If building owners want to have a general audit combining these two approaches, make sure that their service providers can demonstrate several levels of expertise (regarding reuse, recycling, hazardous substances, etc.).

Reclamation audit: preliminary visual assessment only	Hazardous substances audits (asbestos survey, lead, etc.)	Reclamation audit	Spare time to identify effective reuse opportunities or reclamation dealers	Reclamation and demolition (or refurbishments) specifications	Reclamation operation	
Pre-demolition audit					Demolition (or refurbishment) works	

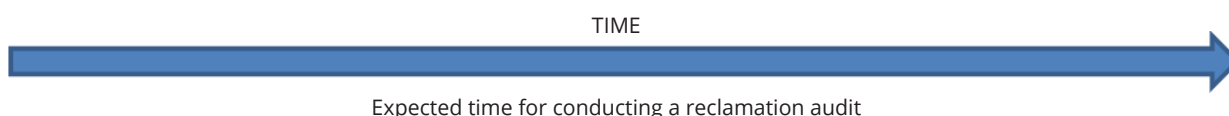

2. Who can conduct a reclamation audit?

2. Who can conduct a reclamation audit?

Various actors can conduct a reclamation audit. The choice for one or a combination of them will depend on the objectives, the general context (type of building, available means...) and the timing (see supra) of the project. The following table presents an overview of the benefits and limitations of the different actors:

Architects

Benefits

- ✓ Are able and used to assessing the value of a component according to a holistic approach, considering criteria such as technical, economic, environmental, design and cultural aspects.
- ✓ Can conduct the inventory with a new project in mind and can therefore spot direct opportunities for reuse.

Limitations

- X May not be involved in the decision as to whether to demolish the building. May be contracted after the demolition.
- X The mission brief for the project team needs to include this mission (and honorarium needs to be adapted accordingly).
- X Some architects still prefer to work from a clean slate and not rely on the existing reusable elements.
- X Usually aren't familiar with the reuse market.

It is appropriate for architects to conduct reclamation audits in the following cases:

- In renovation projects in which they are asked to integrate reclaimed elements and given the opportunity to source (part of) these from the existing building (same-site reuse).

Building owners

Benefits

- ✓ Can intervene upstream in the process and adapt their project ambitions accordingly.
- ✓ Can conduct the first audit internally (no need to contract its execution).
- ✓ When managing different construction sites in parallel, can spot 'site-to-site'¹⁸ reuse opportunities.
- ✓ When public authority: have a good overview on the procurement strategy and can adapt it according to opportunities.

Limitations

- X Generally has limited technical knowledge (on dangerous substances, disassembly...).
- X Do not often have the means to conduct exhaustive audits in large buildings.

It is appropriate for building owners to conduct reclamation audits in the following cases:

- To conduct the first step of a light assessment, which will indicate whether a further and more ambitious salvage operation is required. They can then be assisted by other professionals.

8 See Annex 1 : Glossary

Construction controllers

Benefits

- ✓ Have broad technical and legislation knowledge.

Limitations

- X May have limited experience of reuse.

It is appropriate for these building experts to be involved in reclamation audits in the following cases:

- When they are already involved in another type of audit (pre-demolition audit), they may conduct an initial assessment. They can then be assisted by other professionals who have reuse expertise.

Construction and demolition contractors

Benefits

Demolition contractors

- ✓ Can give an accurate estimation of the technical challenges posed by deconstruction.

Limitations

- X Risk of conflicts of interest on quantitative targets/ambitions.
- X Lack of experience in identifying reuse opportunities.

Construction contractors

- ✓ Can spot in-situ and site-to-site reuse opportunities on other construction sites.

It is appropriate for that the contractors to be involved in case:

- They need to reuse materials in situ and to be consulted regarding the technical and logistical feasibility of reusing a product.

It is appropriate for demolition contractors to be consulted in case of:

- More complex deconstruction processes or to plan logistics.

Reclamation dealers

Benefits

- ✓ Have a good knowledge of the market for reclaimed construction elements and their value.
- ✓ Can give valuable insights into the conditions that are likely to affect the 'reusability' of a given element.
- ✓ For reusable elements, can consequently ensure their effective circulation towards new uses.

Limitations

- X Can have a narrow or biased view depending on their market segment.
- X Unlikely to identify more innovative or less common reuse opportunities.
- X Can negate reclaimable products because they don't see their resale value.
- X Can have limited technical and legislation knowledge of construction.

It is appropriate for reclamation dealers to conduct a reclamation audit in the following cases:

- When the building contains elements for which there is already a well-developed market or when there are a large number of elements in their market segments.
- When the building owners does not aim at conducting an exhaustive reclamation audit but rather wishes to salvage the 'quick wins'.
- When the salvage operation needs to be break-even or cost-saving for the client.

Reuse Experts

Benefits

- ✓ Have the expertise to spot reusable products and assess their potential.
- ✓ Can be external actors who liaise with the different stakeholders: architects, contractors, clients.
- ✓ Can suggest different (innovative) reuse opportunities and assess their feasibility, combining both the existing market and the opportunities offered by an architectural project.
- ✓ Can provide input on performance that need to be proved for effective reuse.

Limitations

- X Their function is still in development and is relatively uncommon and uncertified.
- X Need to be contracted.

It is appropriate for reuse experts to conduct reclamation audits in the following cases:

- When the reuse ambitions of the client are high, when the size of the building is substantial or when the audit is part of a larger reuse or waste management strategy.
- When there are dedicated means for undertaking large-scale reuse operations.
- When the client wishes to have both a broad overview of the possibilities at stake and an initial estimation of their consequences (in terms of planning, budget, procurement, logistics, etc.).

3. Which reuse destinations?

'Newcomers on the market'

Large-scale development projects that come with a demand for large quantities of reclaimed products are an excellent leverage to strengthen and expand the existing reclamation market. In some cases, a large operation can help support new investments in R&D, machinery and services. It can even trigger the start up of a new company. This is well illustrated in the example of the Pulse project, in the Parisian region, in which a single demand for 22,000 m² of reclaimed raised floor enabled the company Mobius to develop a new business model around this product, which wasn't commonly found on the reclamation market until then.

In response to this demand, the company extended the services associated with materials. They are now supplying their clients with warranties on the products and carbon footprint assessments.

Images : <https://www.bellastock.com/projets/pulse/> & <https://www.mobius-reemploi.fr/>

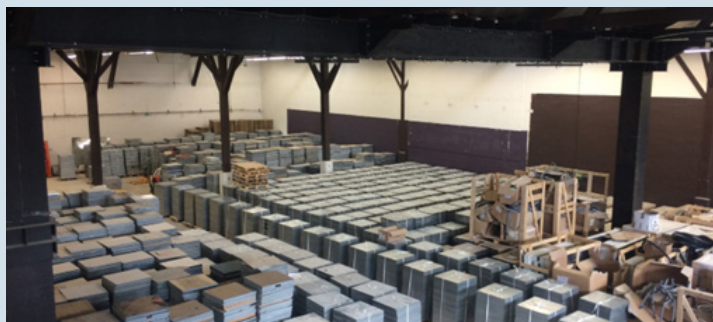

3. Which reuse destinations?

The main purpose of a reclamation audit is to provide a good estimation of reuse possibilities and to provide a detailed list of elements presenting a strong potential for reuse in a given context.

Assessing the reuse potential is not an exact science but it does not mean that it should be undertaken arbitrarily. As explained below, the reuse potential of a given element depends on different factors. Some can be measured accurately while others involve a certain degree of appreciation. The personal experience and professional background of the auditor, including the skills developed through prior experience are generally very valuable. There are, however, guidelines to assist newcomers and experts with experience on how to make a successful assessment.

The reuse potential can only be confirmed (or not) when a product is effectively reused as an integrated part in a project. In this regard, the reuse potential of a construction element is ultimately correlated to the existence (or creation) of a demand (opportunity) for this element.

The demand can originate from various sources: the reuse ambitions of a new project, the reclamation market, or other channels.

The reclamation market

Some construction elements are commonly reclaimed by professional companies. These dealers have largely developed their activities, so that they can undertake a large number of operations that will ensure the effective reuse of certain elements: dismantling, sorting, cleaning, processing, stockholding, documenting, selling, pre-financing some operations, etc.

- This channel has the advantage of being predictable and stable. It will be likely to work for the majority of projects.
- It also comes with a few disadvantages: it is limited to the existing supply of existing markets, existing dealers are not always keen to explore new paths and new products, it is limited to products that have proved to be economically viable.

Most suitable for this channel are the elements that can be found on directories such as Salvoweb and Opalis, such as solid bricks, floor tiles, doors, windows, wooden elements, parquets, steel structures, cast-iron radiators, antiques, etc. These 'commonly reclaimed construction products' are briefly listed in the chapter 'Commonly reclaimed construction products' (see 5.2.1)⁹.

Note that the market is not static. It is able to evolve thanks to new dealers supplying new types of reclaimed products – or existing dealers expanding their supply. Some projects can even trigger the market (see example on the left). Market evolutions usually correspond to new types and trends of demand or design. Construction elements that are not commonly reused today could become the bestsellers in a few years' time.

9 And further explained in Annex 3

Concrete slabs reused on-site

A reclamation audit conducted in a large housing estate in the city of Stains (France) highlighted the massive presence of concrete elements. This huge potential prompted the social landlord to develop a local chain of actors that would transform concrete slabs into building and landscaping material to be reused on site.

This operation took advantage of the existing material and human resources and created local jobs.

Images: courtesy of Bellastock



Site-to-site reuse: from partition walls to insulation panels

The refurbishment of an office building in Brussels involved the removal of approximately 4 linear km of partition walls. The building owner wanted to salvage these.

As a matter of fact, the contractor hired for the project was currently busy with the refurbishment of 341 social houses, for which they needed a large quantity of insulation panels. They discovered that they could reclaim the insulation panels contained in the partition walls to insulate the roofs of these houses. Following the building commissioner's approval, the insulation panels had to be tested to ensure their thermal conductivity. A test in a laboratory demonstrated satisfactory results and led to the reclamation: dismantling of the partition walls, conditioning, temporary storage and re-installation in the second project.

<https://www.rsz.fgov.be/fr/news/851/l-onss-est-couronne-pour-lamenagement-du-batiment-horta-grace-une-approche-circulaire>

Images: <https://www.circulareconomy.brussels/des-cloisons-qui-rapprochent-les-gens-projet-onss-horta-marc-vanderick/>

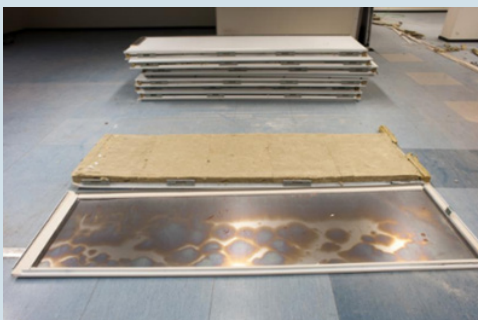

A specific project

The design of a construction project can be an excellent opportunity to integrate reclaimed construction products. A project can thus trigger a demand for specific products. This project can be executed at the same place as the deconstruction (same-site reuse) but it can also be on another site (site-to-site reuse)¹⁰.

- This solution is more 'opportunity dependent' than the reclamation market. This route depends on either a coincidence or an explicit demand that can be foreseen from the start of the project (explicitly created link) between a demolition project and a construction project: the window of opportunity can therefore be relatively small.
- It requires logistical solutions (mostly regarding temporary storage). It also requires excellent coordination between dismantling, design and construction phases
- It implies that the architects and contractors work with a few uncertainties: quantities that will be effectively available, installing materials that have not been bought by the contractor, etc.
- The main advantage here is that it becomes possible to reuse elements for which there is currently no stable or established market. Innovative types of reuse can be imagined in this context¹¹.
- It is also a chance to reduce construction costs by using 'free materials' and by cutting waste management costs. In some cases, transport (off site) is not necessary.

The best candidates for this route will depend on the requirement of each project. Commonly reused materials are good candidates in this case too. However, with the right team and means, very innovative types of reuse can also be anticipated (reusing entire structures, prefab concrete elements, etc.). In these cases, some specific assistance may be required to assess technical and economic issues. This is where reclamation audits may include feasibility studies. Not only is the audit revealing a potential, but it is also providing recommendations on its implementation in practice.

Other channels

Aside from these two main options, demand can take other forms.

- The holders of reusable building elements (building owners or their contractors) can put these up for sale on online marketplaces, either addressed to private consumers and/or businesses¹².
- The holders of the reusable materials can also foster donation systems. This route is suitable for elements which present a good reuse potential but lack economic value (due to low quantity, for instance). Donations are also becoming increasingly common between large contractors who start to 'swap' materials.

These channels are more context-dependent. They will not be explored any further in this document.

10 A contractor involved in a project may, for example, identify an opportunity to reuse a construction element in another ongoing construction site.

11 Here too, the demand can therefore be stimulated and created even if no market existed prior to this reuse operation.

12 Werflink, for example, "*is a platform dedicated to sharing construction equipment, materials and waste between companies active in the construction sector*" <https://www.werflink.com/en-werflink.html>

A reuse marketplace dedicated to donation

This British company helps businesses reduce waste by providing a marketplace for listing unwanted items and by connecting corporate bodies to charities and people to redistribute them. All items are free for collection by charities, SMEs and individuals. Globechain focuses notably on the construction sector, and in particular materials from refurbishments, and demolition.

An example of its case studies is The Conduit which was converting a hotel into a private members club and wanted to reuse and repurpose as much as possible. That which wasn't reused on site was donated with the help of the marketplace. Products such as carpet, ceiling tiles, fire doors, wooden flooring, pillars, glass partitions or skirting were notably reclaimed.

Images: <http://www.verdextra.com/theconduit>



4. How ambitions define the type of approach?

4. How ambitions define the type of approach

The main incentives for conducting a reclamation audit prior to demolition can vary:

- **Voluntary:** in the perspective of a better management of resources: it is clearly a good practice¹³. Assessing the reuse potential of a building is the first step towards preventing unnecessary waste, avoiding end-of-life treatments and keeping valuable resources in circulation and reducing the demand for new products.
- **Economic:** instead of wasting materials (and paying for disposing of waste), there is an opportunity to earn a profit from the sale of the materials.
- **Policy-led:** the demand can equally come from (European) non-binding regulations or regional or local governmental ambitions. Many regulations and policies support this activity which, depending on the region, may turn out to be mandatory¹⁴.
- **Certifying and qualifying:** conducting an audit can also be driven as part of a labelling process, certification scheme, image building or be a condition for receiving support from public funding.

13 Communication from the Commission to the European Parliament, the Council, the European Economic and Social Committee and the Committee of the Regions, *Closing the loop -An EU action plan for the Circular Economy*, Brussels, 2 December 2015, COM(2015) 614 Final. Available online: <https://eur-lex.europa.eu/legal-content/EN/TXT/?qid=1453384154337&uri=CELEX:52015DC0614>

European Commission, Directorate-General for Internal market, Industry, Entrepreneurship and SMEs. *Guidelines for the waste audits before demolition and renovation works of buildings. EU Construction and Demolition Waste Management*. May 2018. Available online: <https://ec.europa.eu/docsroom/documents/31521/attachments/1/translations/en/renditions/native>

Development of a guidance document on best practices in the extractive waste management plans, <https://op.europa.eu/en/publication-detail/-/publication/f18472f8-36aa-11e9-8d04-01aa75ed71a1/language-en/format-PDF/source-87989698>

Directive 2008/98/EC of the European Parliament and of the Council of 19 November 2008 on waste and repealing certain Directives. Available online: <https://eur-lex.europa.eu/legal-content/EN/TXT/?uri=CELEX%3A32008L0098>

14 Cf. *Review of existing pre-demolition tools, policies, resources for identifying, quantifying and organising the reclamation of reusable elements*, Available online: https://www.nweurope.eu/media/8917/fcrbe_wpt2_d11_20190927-for-publication.pdf

Defining the ambitions and the scope of the audit

Before starting an audit, it is important to understand the motivations of the stakeholders, the incentives and the context in which it takes place.

Clarifying certain aspects early on with the building owner will allow for this understanding. The following aspects will be useful to specify in this context:

Criteria	Examples of relevant questions to ask
<i>Contingent opportunities</i>	<ul style="list-style-type: none"><input type="checkbox"/> <i>Is there flexibility in the final channels allowing for different reuse potentialities (sale, donation, same-site, site-to-site)?</i><input type="checkbox"/> <i>Is there a new project development that could foster same-site reuse opportunities?</i><input type="checkbox"/> <i>Are there local reclamation dealers specialised in some types of building materials and products?</i><input type="checkbox"/> <i>Is there an ongoing project in the area that could benefit from reclaimed products?</i>
<i>Openness for exploration</i>	<ul style="list-style-type: none"><input type="checkbox"/> <i>Is there an opportunity to test or open a new market?</i>
<i>Commitment to the environment</i>	<ul style="list-style-type: none"><input type="checkbox"/> <i>Are the stakeholders committed to lowering their environmental impact?</i><input type="checkbox"/> <i>Is the new project aiming for a green building certification scheme?</i><input type="checkbox"/> <i>Are there local policies and regulations regarding reclamation and reuse?</i><input type="checkbox"/> <i>Is there a need to be exemplary in terms of respecting the environment?</i>
<i>Economy</i>	<ul style="list-style-type: none"><input type="checkbox"/> <i>Are there specific means dedicated to this operation? Is there the possibility of public funding?</i><input type="checkbox"/> <i>Should the reclamation operations be cost-neutral?</i><input type="checkbox"/> <i>Is the building owner expecting a return on investment for the reclamation operations? If so, in what form? Acquiring cheaper building materials, raising its profile for communication purposes, generating incomes?</i>
<i>Timing</i>	<ul style="list-style-type: none"><input type="checkbox"/> <i>How long will the operation take?</i>
<i>Human resources</i>	<ul style="list-style-type: none"><input type="checkbox"/> <i>Are there stakeholders around the table who are already involved and are able to conduct a reclamation audit?</i><input type="checkbox"/> <i>Is there the possibility of contracting local experts?</i>

→ Assessing these criteria will help to define the scope of the audit: from a very light to a more exhaustive one. It will also influence who should conduct it (internally or externally).

Principal audit approaches

Different economies fall under these possible approaches.

1. In certain projects, there is a large **economic interest** for reclaimers or contractors for **very specific elements**. These often concern historical pieces or architectural antiques. Building owners (including public ones) can hope to earn a profit by selling reusable products when their building contains elements of a high value. For these elements, the **audit** will usually remain **very light**: it is mostly a question of assessing and confirming their value and identifying a potential buyer/market.
2. Salvaging reusable elements also contributes to lowering the quantity of C&D waste that needs to be removed. This can help to **mitigate the expenses related to demolition and waste treatment**. In return, reclaimed materials can **generate income**, resulting in most cases in a **break-even situation** for the building owner or executor of both activities. Overall, it will not severely affect the client's budget, while fostering much more respectful practices.

This approach works particularly well in a scenario in which the reclamation audit is carried out by the operator who is also likely to reclaim the materials. Most reclamation dealers can provide a quick preliminary assessment of the main reuse opportunities for free. A **light inventory** completed by the building owner (or their consultant) and sent by mail is often sufficient enough for them to assess the main opportunities. Some reclamation traders will even visit the building to assess it, as part of their surveying efforts, if they see a high potential for them.

This approach is limited to the products that are **commonly reclaimed** in the current economical context which, these days, correspond to a relatively small fraction of all of the materials coming out of recent buildings.

3. A third scenario, more ambitious, is conducting a more **exhaustive audit** in line with the ambitions of the project. Such an **audit** will usually be much **more complete**, and point out the many different (sometimes innovative) possibilities for reusing elements. The assessment can be complemented by **additional research and studies** to verify some aspects affecting the reuse potential: environmental (carbon savings), economic, social, technical issues, etc. It can foster same-site reuse by demonstrating how elements could be implemented in the new project.

Such an audit **will cost more**, however may lead to **potential cost-savings** by mitigating the expenses for new products (although the cost of additional operations must be considered: dismantling, cleaning, preparation, etc.). It can also be seen as an investment as it will likely be **motivated by other drivers** than mere economic efficiency: an environmental ambition, public funding¹⁵, the context of a pilot project, a will to innovate, and ambition to display exemplary behaviour, etc.

→ For a comparable building size, the first two scenarios can take relatively little time: sometimes only a few hours; the third type can take up to a few days and needs more coordination and alignment with all actors in the process.

15 In an incentive-based dynamic, public funding notably allows financial risks that voluntary private parties are taking, in experimenting more actively new practices in the field, to be reduced. A related benefit for the public sector consists in accumulating know-how from those experiences and sharing inherent good practices. In this sense, it constitutes an important lever for changing practices and habits, making them more accessible.

5. How do you conduct the reclamation audit?

Soon to be demolished building



Reuse potential?

RECLAMATION AUDIT

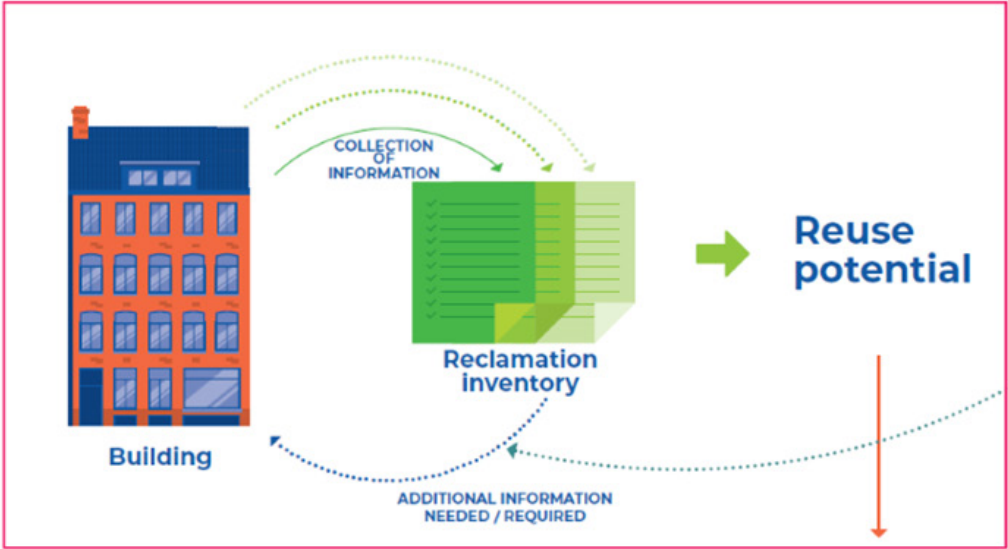

- Reclamation market
- Same-site reuse
- Site-to-site reuse
- Donation

No



Waste treatment and high-grade recycling (selective deconstruction)

5. How do you conduct the reclamation audit?

5.1. Introduction to the process

Conducting a reclamation audit consists of identifying building materials and elements and collecting sufficient information on these. It will allow checks to be made on whether there is an actual demand for the identified products.

The general approach can be divided in three steps:

- **Identifying potentially reusable products** (see 5.2). Two complementary approaches to assess the reuse potential of the materials present in the building can be followed:

1. Proceeding by analogy with commonly reclaimed products
2. Assessing elements through a set of criteria

The objective is to create an initial list of potentially reusable products and to have an initial estimation of the scale of the possible operations: is the building a possible gold mine or, on the contrary, are important obstacles expected regarding reclamation?

- **Collecting the right information (and organising it)** (see 5.3) A two-fold procedure is proposed:

1. Collecting and organising primary data > *template sheet 1*¹⁶: It corresponds to product characteristics that are almost always required, whatever the considered channel (same-site reuse, reclamation market or any other reuse path) (see 5.3.2).
2. Collecting and organising complementary data (possibly through successive iterations) > *template sheet 2*: They consolidate the description of the identified item(s) and provide a better overview of its (their) reuse potential (see 5.3.3).

- Ultimately, different channels are presented for **conveying the reclamation audit to potential users**. This should lead to setting up the actual reclamation operation (see 5.4).

→ This process is usually dynamic and **iterative** (see figure on the left), allowing to go back and forth between:

- The inspection of the building and documentation
- The completion of the inventory and its annexes

particularly if some information is missing, if more investigations are required to confirm the reusability or to meet stakeholders' requirements. Additional studies can then be conducted¹⁷.

→ Where possible, the best way to proceed is to **interact with potential end users of reclaimed products**. Be they architects, local salvage dealers or any other potential future users, their interest in a certain batch will depend on criteria such as the type of elements at stake, quantity or general condition. This interaction(s) determine what type of information has to be collected. If the future users are not known when the reclamation audit is conducted, it is important to adapt the nature, quantity and level of information collected to the most plausible scenario (see 5.3.4 for a concrete example).

¹⁶ The suggested templates (Annex 2) can be used as a ready-to-use model or as a source of inspiration to be adapted according to your project, practices and characteristics.

¹⁷ For example: confirming dismantling-related or technical properties, studying the economic viability of the reclamation operation or the environmental impact of the operation.

Commonly reclaimed products

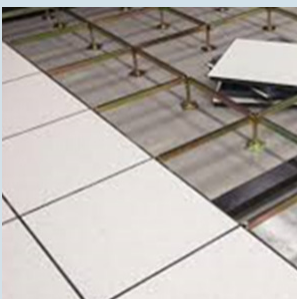
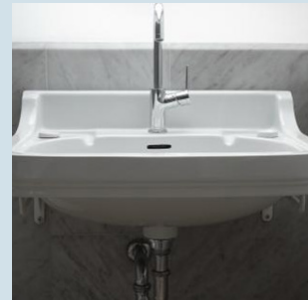
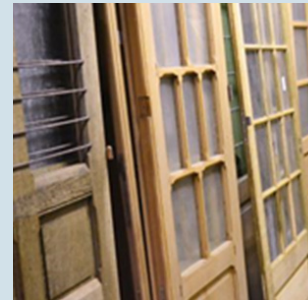
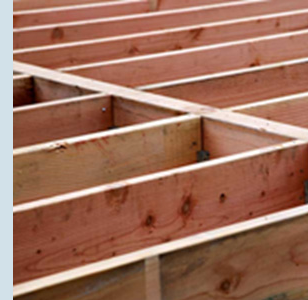
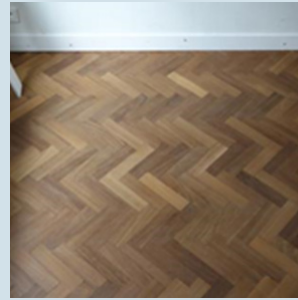

Images: <https://opalis.eu/fr/materiaux> and <https://changingmarkets.org/wp-content/uploads/2017/02/French-carpet-report.pdf>

5.2. How to identify potentially reusable products in an existing building?

The manual proposes two methods for assessing the reuse potential of a building material. Both are compatible:

1. Proceeding by analogy with commonly reclaimed products
2. Following general influence criteria

5.2.1. Proceeding by analogy: commonly reclaimed construction products

A good way to assess the reuse potential is to check whether a specific market or purpose already exists and is known by the auditor¹⁸.

The auditor can count on 'bestsellers' that are easy to identify and will most likely find an interested party.

This relates to products and elements such as:

- *Solid bricks (specific ages, specific connection methods)*
- *Roof tiles/slates*
- *Timber*
 - *Timber floorboards and block floors*
 - *Timber joists and studwork*
 - *Cladding*
- *Floor and wall tiles*
- *Structural steel*
- *Doors*
- *Double glazed window frames*
- *Cast iron radiators*
- *Luminaries*
- *Sanitary equipment*
- *Stone thresholds, steps, walling and pavements*
- *Road components: pavers and setts, kerb stones and concrete paving slabs*
- *Antiques and architectural elements: columns, wood panelling, mantels, finely crafted sideboards, sculptures, ...*

If '**commonly reclaimed**' infers that a stable and extended market exists, sometimes this is not the case.

Some products, more specifically, relate to elements from a project opportunity, consisting of newcomers on the market, or existing in a limited specialised or regional market. Those products are usually easy to dismantle, store, have standard dimensions, proven quality and are often present in large quantities. These elements are mainly found in tertiary buildings (commercial, industrial or office buildings).

This refers to products and elements such as:

- *Technical equipment*
- *Raised floors and their support systems*
- *Rolls or panels of insulation*
- *Carpet tiles*
- *Entire building structures or specific entities such as portal frame structures, sheds, greenhouses, mezzanine entities, etc.*

→ More information on the different products listed here is provided in Annex 3: Commonly reclaimed construction products.

→ This list of products and materials is not complete and does not guarantee a buyer in the end. To be more precise and critical about these products, the next chapter provides a list of objective criteria that can affect the reuse potential of these elements.

¹⁸ It is always possible to check the reclamation market and local characteristics by consulting online platforms or guidelines such as Opalis, WRAP – Reclaimed building products guide (UK) or Salvoweb.

5.2.2. Following general influence criteria

The literature regarding reuse¹⁹ and the experience of the actors involved has defined a set of factors affecting the reusability of a construction product. The auditor can use these elements in the decision-making process.

Some specific factors influence the assessment of a reuse potential in a positive or in a negative way. They are listed below, and are complemented by some main concerns:

Positive influence criteria

- ✓ **Good condition**
 - Is the element in good condition?*
 - Is there any damage?*
 - Does it need an intense clean or refitting?*
 - *A visual and inspection can already provide information on this criterion.*

- ✓ **Sufficient quantities**
 - Is the batch large enough to justify the deconstruction?*
 - *Some reclamation dealers will even come to the site to get the elements if the quantity is good enough – but equally they will decline a batch if it is too small or too big.*

- ✓ **Homogeneity or standard dimensions**
 - Is the product of standard size?*
 - Are the products homogeneous regarding their dimensions?*

- ✓ **Authenticity and value**
 - Is the product scarce? Are there equivalents today? Was it created by a famous designer/architect? Does it concern a well-known brand? Is it signed?*
 - Is there some heritage value? A reference to local conditions, know-how, history?*
 - Does the product consist of an interesting alternative to a new equivalent product?*
 - Does the product have interesting or appreciated aesthetic qualities?*

- ✓ **Economic value**
 - Is there a demand on the market? Is it a recurring item? (the technical properties are easily accepted without heavy investigation).*
 - *See products listed in the first section of this chapter.*
 - Is its price comparable or more interesting than a new equivalent or alternative?*
 - Will it be possible to cover the cost of labour it requires? Duration and cost of deconstruction compared to a more 'brutal' demolition?*

19 see: Annex 7, Further reading

✓ **Facility of dismantling**

- ☐ Can the element be dismantled without altering its mechanical performances and aesthetic aspects?
- ☐ Is dismantling technically feasible?
 - The use of some glues or cement-based mortars can prevent the chances of properly dismantling an element. Some elements will also crumble once taken out of their initial place.
- ☐ Is the element easily and safely accessible?

✓ **Manageable logistics**

Concerning the deconstruction logistics (how, what tools and equipment to use, how long it will take etc.), it will later be appointed to a contractor or the reclamation dealer directly, who will know how to handle the deconstruction. However, it is still useful to anticipate certain aspects that will impact the reclaimability.

- ☐ Is the element easy to handle (in terms of weight, volume, fragility)?
- ☐ Can it be easily and safely transported, stored, processed, and re-installed without damaging its original quality? On the contrary, does it require specific handling equipment (cranes, specific trucks, heavy treatments, etc.)?
 - Some deconstruction (and reprocessing) tests can be carried out to test different methods of deconstruction: what tools to use, what timing, but also to evaluate the loss rate or the volume collected.
- ☐ Are there operators to reclaim it? Who will be involved? Does a 'chain of actors' exist? (deconstruction, sorting, storage, cleaning, repairing) or is there an existing infrastructure to manage the logistics?
- ☐ Is the site easily and safely accessible for cars, trucks, cranes, etc.? Is there enough free space to execute the dismantling? In case of same-site reuse, are there good conditions to safely store the dismantled elements and process them? Should an off-site solution be found?
 - If the building is in a dense city, the deconstruction will take longer because there are more constraints: noise, dust, space, traffic, preservation of surrounding buildings, etc.
 - If the operation can be performed on site, it will be easier from a logistics point of view: easy to see the stock, space to sort out elements, to bring heavy/large equipment (mobile crane) on site, to process and store the product on-site.
- ☐ Is the dismantling phase compatible with the general demolition work?

✓ **Carbon savings and durability**

- ☐ From an environmental point of view, it is sensible to reuse elements for which the production generates a heavy environmental impact. It can be considered a means of preventing new production or a way to capture the carbon-footprint of an existing element.
- ☐ Although assessing the precise environmental impact of a product requires a complex approach (i.e. LCA), a quick estimation of the order of magnitude can easily be found in literature or online.

Negative influence criteria

- X **Health and safety issues**
 - ☐ Hazardous substances: The presence of chemicals (lead, asbestos, etc.) or biological (fungus, etc.) substances can severely hinder the reuse potential.
 - Hazardous substances should be identified and treated by experts. They cannot be reused. In some cases, and given the right working conditions, polluting substances can be removed to ensure the reuse of a product. This should be evaluated and executed by experts and professionals.
 - ☐ Safety risk: Are the dismantling and subsequent operations presenting any health and safety risk?
- X **Low performance and/or the absence of documentation on performance**
 - ☐ For technical equipment, new performance requirements are likely to outdate older products. Most older lighting systems that are not integrating led technology are probably not worth reusing, except, of course, if their value makes it worth refitting them.
 - ☐ Equally penalising could be the absence of information on technical performances (especially for highly demanding uses) or the origin of the material.
- X **Poor condition/alterations**
 - ☐ Materials that are clearly in bad condition (e.g.: damaged during the first implantation) or at the end of their life are not suitable for reuse.
 - ☐ Materials severely altered by adverse conditions such as leaking, weathering, fatigue, fire, cracks, structural failures (risk of breaking/collapse, etc.) or improper implementation or dismantling operations, should not be reused.
- X **Obsolete, out-dated**
 - ☐ Some construction products become obsolete through new ways of life. Therefore, the demand for these products will likely be very low or inexistent. E.g.: bidets.
 - ☐ Equally impacting are the trends in design and architecture. E.g.: In the 1960s, Art-Nouveau buildings used to be torn down with no afterthoughts. Nowadays, an Art-Nouveau ironwork is sold for thousands of euros in auction houses.
 - Although fairly elusive and ever-changing, these trends have a strong impact on the construction industry and strongly affect the reuse potential (especially for finishing materials).
 - ☐ Is the material/product complying with current technical standards?
 - The evolution of normative and regulatory frameworks can contribute to the obsolescence of some construction products.
 - Most of these rules apply to specific uses, offering less demanding reuse opportunities. (i.e. cascading).

- None of these influence criteria, neither positive nor negative, are completely determining. However, this general overview gives a good indication of the different aspects and factors an auditor should take into account when completing the inventory of potential reusable elements in a typical context.
- Of course, all these aspects can be aligned to the client's needs and requirements²⁰. Ponderation may be necessary. For instance, the auditor can decide that the environmental impact assessment should outweigh considerations on fashion or aesthetics. Annex 4 provides a few examples on the way the criteria mentioned above can foster reuse.

20 See Chapter 4.

5.3. What information should be collected and how should it be listed in an inventory?

In this chapter, the type of information needed to be collected is examined, as well as the way to proceed and to collect.

5.3.1. The right state of mind

First of all, it is important to mention that conducting a reclamation audit requires a balanced approach from the auditor, an open mind, and:

- **Curiosity:** There is always more than meets the eye. A wall full of graffiti²¹ can hide perfectly reusable bricks, or a gorgeous parquet can be covered by a degraded carpet. Also, some elements will need further checks and validation before their reuse potential can be fully expressed.
- **Cautiousness:** Some factors can seriously hinder the reuse potential. These are not always visible at first sight. The beautiful parquet mentioned above may be glued using a toxic tar-based glue²². Some assemblages are almost impossible to dismantle properly. Some construction elements can be unsuitable or complicated to reuse. It is essential to remain alert to asbestos and exercise caution while investigating materials and elements.
- **Flexibility:** It is important to remember that the reuse market is a constantly changing sector and that there is no standard for identifying reusable materials. There are only possible approaches to constantly update with new experience on a case-to-case basis. Nevertheless, auditors should not hesitate to trust their common sense in the early stages of reflection. Simple questions such as 'If I had the opportunity, would I reuse it myself?' or 'Should it really be discarded as waste?' can be enlightening.
- **Proportionality:** Any reclamation audit takes place in a specific context, with specific means and targets. The auditor should consider the correct balance between the efforts put into the reclamation audit and its inventory and the reuse ambitions relating to the context in which the audit is conducted. It might be useless to compile an exhaustive reclamation inventory for undertaking a careful dismantling if resources are missing. On the contrary, a reclamation inventory with only two entries for a client contracting an exhaustive mission or for an architect willing to push forward same-site reuse would be equally disproportionate.
- **Alert to a possible assistance:** When uncertain, assistance can be requested: an architect, a reclamation dealer, a demolition contractor... who can usually all offer valuable insights into the reuse potential of a specific element. Some products might have an unpredictable potential for reuse.

21 Which could possibly be reclaimed intact, or cut into sections, and sold as art or kept as a memento for social benefits in the new scheme.

22 Which, for example, with benzopyrene in asphalt, may be an issue in one country but not another.

5.3.2. Template 1 – Primary information (see Annex 2 – sheet 1)

This chapter provides information on primary data that is almost always required and will need to be listed, and information on how to collect it.

The annexed template (Annex 2) – sheet 1 follows the following structure and can be completed progressively:

5.3.2.1. Prerequisite: general context information

Note that providing information on the general context in which the audit is conducted constitutes a prerequisite. This information will help to refer to the document and trace the parties who were involved:

- Reference and title of the document
- Date of inventory
- Date of the site visit(s)
- Contracting authority details: name, address, contact details
- Auditor details: name, address, contact details
- General information on the audited (part of the) building: name, address, contact person, other relevant information
 - Note: This section may provide indications on the type of building and its location. In some contexts, these indications need to be accurate by ensuring:
 - Use and classification of the building according to legislation²³
 - Building location according to seismic zones, altitude, wind classification or snow classification (if item outside)
- Indication related to the consultation of any type of audits/inventories (asbestos, waste,...)
- In case of necessity: planning of the project activities/stages

Template 1: general context information

RECLAMATION INVENTORY			
GENERAL CONTEXT INFORMATION			
REFERENCE DATE INVENTORY DATE OF THE SITE VISIT(S)			
INVENTORY DOCUMENT Annexes to primary data			
CONTRACTING AUTHORITY name address tel/ mail			
AUDITOR INFORMATION name address tel/ mail (contact person)			
AUDITED BUILDING (or part of -) name address tel/ mail (contact in situ)			
BUILDING OWNER INFORMATION name address tel/ mail (contact person)			
BUILDING INFORMATION e.g. type of building, location, etc.			
AUDITS/ INVENTORIES Did you consult any type of audits/ inventories while doing this reclamation inventory?	<table border="1"> <tr> <td>NO</td> </tr> <tr> <td>YES</td> </tr> </table>	NO	YES
NO			
YES			
If yes, which one(s)?			
PLANNING OF THE PROJECT ACTIVITIES/ STAGE			

23 In France, for instance, it is according to the fire legislation; a building could be an ERP (public building) 1st category type R (schools), for example.

5.3.2.2. Collected data and form

Collecting and organising primary product information will help to create the first listing of materials with their main properties. Primary information will mainly be collected during a first walk-through of the audited building allowing for a careful examination of the surrounding elements and listing those estimated to have a reuse potential, or during a desk study of the existing building documents. Where possible, it is appropriate to have a look behind the finishing materials to locate the structural core.

The primary information sheet of the inventory takes the form of a table in which each line corresponds to an entry. Each entry corresponds to a coherent batch of materials or elements. Encoding following data for each potentially reusable element will provide this first listing of materials. It should remain objective, concise and factual data and be expressed in a way that avoids any ambiguity.

Template 1 : primary information

PRIMARY INFORMATION												
Identification		Picture	Quantity		Dimensions		Mass			Location in situ	Condition	Remark(s)
nbr.	item name		unity	nbr.	unity	dim.	unity	nbr.	total lot			

a. Item identification

This identification consists of providing each spotted element an item name, preceded by an item number, for easy reference.

Considering the item name, it is important to be precise, but it is not necessary to make it too long. It is predominantly needed so that you can refer to a specific batch/package without confusing it with another. Similar elements may be brought together but attention should be paid to false friends: some variations may justify a distinction between two entries.

Examples: 'travertine window ledges', 'blue pedestal wash basins', 'cast-iron radiators (6 columns, with feet)', 'black cast-iron radiators (4 columns, hanged)'.

b. Picture

Different pictures of the element can illustrate the item. For example: a general overview of the material, a larger overview on the context, a few close-ups on specific details. Annex 5 provides more recommendations on how to take a good reclamation picture.

In the first list of materials, one representative picture presenting the identified product in its context as clearly as possible will help potential acquirers to determine whether it is of potential interest.

c. Quantity

Introduction of the quantity (or estimation, if applicable²⁴) of the item identified on site using commonly used units for the materials concerned: number of pieces, linear metres, square metres, cubic metres... This information is key to matching the batch with a future use. Reclamation dealers will, for instance, also assess whether the quantity may justify transport.

d. Dimensions

Introduction of the dimensions (or estimation, if applicable²⁴) with an indication of the used unit. This is also key to matching the batch with a future use and for logistical aspects. For example, can this 2.8 × 3.7 m window frame enter the lift, or will it require a crane? Do these marble slabs fit on a classical pallet or will they need specific packaging?

e. Mass

Introduction of mass (weight) per unit, square metre or cubic metre and total mass of the itemised lot/package calculated (or estimation, if applicable²⁴).

This information is useful from a logistical point of view and contributes to the potential assessment of environmental benefit in terms of carbon saving for the product (mass [or m²] × quantity of non-renewable energy per unit of building material, component or system).

It is useful to remember the voluminal mass of common construction materials:

- Pine: 370 kg/m³
- Oak: 710 kg/m³
- Brick: 1,600 to 1,900 kg/m³
- Limestone: ~2,600 kg/m³
- Granite, marble, slate: ~2,700 kg/m³
- Steel: 7,800 kg/m³

It is also worth remembering that a typical Euro pallet has a surface of 1 m². If things are stacked on it up to 1 m high, you roughly have 1 m³.

f. Location (in the building)

This information is required to correctly locate the elements in the building. It is important to avoid confusion (dismantling a material from a wrong floor, for instance) and, more generally, to organise the reclamation process (there can be different work phases corresponding to different building units, for example). The location in the building should be indicated as clearly as possible, especially in large-scale facilities, primarily by mentioning the building unit, floor, room, etc. while being consistent with documents to which the information refers.

Example: Building A, 2nd floor, sanitary room 2.3 - ref. As-build plan dd. 10/01/2017). Indications of the as-built plans can be different from the names given to the rooms by the occupants.

24 In case of an initial stage inventory; to be verified later.

g. Condition

This section should provide information on an assessment of the general condition of the item, by giving an indication of the potential aesthetic and technical alterations affecting a 'good condition' (e.g. presence of cracks, defects, chipped paint, discoloration, deposits, deformations, traces of wear and tear, etc.). For technical equipment, the indication, if possible, if they are still in use/working can be an interesting one.

h. Other remarks

Any other information witnessed on site as relevant to assessing the reuse potential, or any indication on listed data can be completed here.

A good reminder is to ask yourself why this specific element caught your attention. If the reason is not covered by one of the aspects mentioned above, this can be listed in this section. It will help other stakeholders to detect the potential that was seen.

By way of an example, this section could host, in particular:

- A specific technical property (e.g. fire-resistance in the case of fire doors)
 - Overview of preconditions (availability, timing, specific concerns, etc.)
 - The specific characteristic(s) of an indicated information, e.g. average or approximate of a dimension, a quantity, a mass measure, etc.
 - Information on an intended reuse channel (donation/sale/project opportunity/etc.)
 - Any existing inconsistency between itemised information and sources/annexes referred to
- Note: The order in which items are listed can follow different logics. The chosen logic should emanate from the context in which the reclamation audit is conducted. As examples, the following sorting logics may be cited:
- Sorting by quantity
 - Sorting by nature of the construction element (structure, facade elements, finishing elements, technical installations, etc.)
 - Sorting by constituent materials
 - Sorting by commonly reclaimed products
 - Or even sorting by alphabetical order

5.3.2.3. How to collect the data

To create the first listing of the materials, the following equipment will typically be useful during a first walk-through of the audited building (field study):

- A notebook or a tablet
- A device to take pictures
- A flashlight/ torch (e.g. to have a look behind suspended ceilings, in dark corners, or if the general electricity is off)
- The plans and building documents. If these are unavailable, a general sketch or a picture of the fire evacuation plans can be used.
- A metre (ribbon, laser)
- A set of screwdrivers and a small crowbar for simple dismantling
- Safety equipment (hard hat, gloves, glasses, dust mask)²⁵

²⁵ A lot of other tools may also be required for further investigations: chemical tests, thermal camera, humidity testers, etc. But these are more specific items that can be rented or bought in the case that they must be proven to be useful. They will usually be used within the framework of gathering complementary information (see below 5.3.3.2).

In addition to this inspection of the building, a desk study can be conducted to gather this primary information. It consists of collecting and analysing principal existing building documents regarding the building's history and the material properties: plans, technical approvals, measurements, quantity survey, specifications, etc.

This study can be useful for providing information such as quantity, constituent or dimensions. It can also confirm some product's value (historical value, quality material, etc.).

5.3.3. Template 2 – Complementary information (see Annex 2 – sheet 2)

This chapter provides information on complementary data that, in some cases, will establish a better assessment of a reuse potential, and how to collect it.

It works in combination with the annexed template (Annex 2) – sheet 2, which follows the following structure:

5.3.3.1. Collected data and form

In some cases, the primary information (see 5.3.2) will have to be complemented by additional information.

This additional information on certain aspects may influence the reuse potential and confirm the interest of a potential demand.

The complementary data sheet for the inventory takes the form of a more detailed sheet on which each identified item can be further described. Each sheet corresponds to a product listed in the primary information sheet²⁶. They act as a support for the organisation and listing of required and available data. Each sheet is divided into different sections which correspond to different aspects (see below).

The last section of this sheet allows the auditor to wrap up the main elements of the assessment and provide a provisional conclusion on the identified reuse potential of the building material or product considered (with a view to the further steps). This conclusion can take into account economic, environmental, social benefits and information related to preconditions, uncertainties and suggested reuse channels, etc.

In this framework it is important to stress that all information gathered in the inventory is not sufficient enough to assess the 'fitness for (re-)use' of the product, which will need further analysis once this future use will be determined.

In regard to the additional information, different aspects can facilitate a better assessment of its reuse potential. These should stay objective, concise and factual data and be expressed in a way that avoids any ambiguity:

26 However, all of the entries do not necessarily have to be automatically or systematically developed in such a detailed sheet.

Template 2: Complementary Information

Item identification	
nbr.	item name

COMPLEMENTARY INFORMATION					
Complementary pictures					
Item data	<i>Text box to unhide</i>				
Context data	<i>Text box to unhide</i>				
Assembly data	<i>Text box to unhide</i>				
Environmental benefit	<i>Text box to unhide</i>				
Hazardous substances the box may contain: an explicit warning about the product/ a colour code	<i>the element has not been tested and the auditor does not wish to highlight a potential hazard (default settings)</i> <i>the element has not been tested and the auditor does not wish to highlight a potential hazard (default settings)</i> <i>the element has not been tested and the auditor does not wish to highlight a potential hazard (default settings)</i> <i>the element has not been tested and the auditor does not wish to highlight a potential hazard (default settings)</i>				
<table border="1"><tr><td>Green : the element has been tested and does not contain hazardous substance</td><td>Grey : the element has not been tested but the auditor wanted to highlight a potential hazard</td></tr><tr><td>Red : the element has been tested and contain an hazardous substance but can eventually be reuse after treatment</td><td>White: the element has not been tested and the auditor does not wish to highlight a potential hazard</td></tr></table>	Green : the element has been tested and does not contain hazardous substance	Grey : the element has not been tested but the auditor wanted to highlight a potential hazard	Red : the element has been tested and contain an hazardous substance but can eventually be reuse after treatment	White : the element has not been tested and the auditor does not wish to highlight a potential hazard	
Green : the element has been tested and does not contain hazardous substance	Grey : the element has not been tested but the auditor wanted to highlight a potential hazard				
Red : the element has been tested and contain an hazardous substance but can eventually be reuse after treatment	White : the element has not been tested and the auditor does not wish to highlight a potential hazard				
Additional documents	<i>Text box to unhide</i>				
Suggested applications	<i>Text box to unhide</i>				
Others	<i>Text box to unhide</i>				
Identified reuse potential : provisional conclusion					
<i>Text box</i>					

a. Item

This section is about any further description related to the item itself, and can cover aspects such as:

- Brand/technical denomination/product reference/producer references
- More detailed information regarding the condition of the product: alteration/damage, severity, defects, patching interventions, etc.
- Technical/mechanical performances (mechanical, acoustic, thermal, reaction to fire, resistance to fire...)
- Colour, finishing treatments, homogeneity, variability, regularity
- A more detailed description on the constituents, the finishing treatments
- Weight (in kg) of a component or total component mass
- Specific value/interest: historical, aesthetical, economic, scarcity, etc.
- Information on the date of production and implementation
- Conformity/compliance with normative and regulatory frameworks in force (performance, seismic, acoustic, fire, environmental, air quality, dangerous substances, disabled persons' access, etc.)

b. Context

This section is about any further description related to the context itself, and can cover aspects such as:

- More detailed localisation data (including possible additional pictures): What was it used for? In which part of the building? What were the conditions of its use? Are there reasons to believe that the use of this space may have altered the condition of the element concerned? It can be any sort of pollution, unusual stresses (vibrations due to heavy machinery or train lines...), accidents (fire, flooding) or climatic conditions (humidity, extreme heat)
- Building/project information
- Logistical feasibility data: ease of being handled, stored, transported, re-installed, etc
- Availability (period)

c. Assembly

This section covers information relating to the assembly and installation of the product, such as:

- Assembly method of the product (type of attachments, joining methods)
- Dependence on connected building elements
- (Anticipated) dismantling risks and possibilities (alteration of original properties, damaging associated building elements, etc.)

In order to establish a good understanding of this kind of information, you may have to perform dismantling tests (see below, section 5.3.3.2. Dismantling tests).

d. Environmental benefits

Auditors may wish to assess the environmental benefit of reusing a specific building material or products. There are different methods and tools to do so. Some are very extensive and give a detailed evaluation. Others are lighter and give a rough estimation. See below for more information on these approaches (section 5.3.3.2 Environmental impact/benefit studies).

e. Hazardous substances

Hazardous substances may come from different sources: the product itself, its assembly or the context of its implementation. In the inventory, the auditor can summarise all of the information collected on hazardous substances, notably by:

- Cross-checking with other assessments (such as an asbestos survey or a pre-demolition waste audit)
- Specific tests (see below, section 5.3.3.2 . Chemical composition/toxicity)

It is important to be transparent on this issue. In the inventory, the auditor is invited to clearly state if this aspect has been verified (and its results) or whether it has not yet been verified, using:

- An explicit warning about a product
- A colour code:
 - *Green: the element has been tested and does not contain hazardous substances*
 - *Red: the element has been tested and contains a hazardous substance but can eventually be reused following treatment. (If the product cannot be retrieved, it should not be noted in the reclamation inventory)*
 - *Grey: the element has not been tested but the auditor wanted to highlight a potential hazard*
 - *White: the element has not been tested and the auditor does not wish to highlight a potential hazard (default settings)²⁷*

f. Additional documents

All related documents providing a more detailed description of the item concerned can be listed in this section, such as:

- The existence of initial documents (invoices, orders), warranties
- Technical documents/results tests, e.g. permeability, resistance to frost, flexural strength, porosity, hazardous substances, declaration of performance, technical sheet, etc.
- Inventories and audits (asbestos, hazardous substances)/waste management plan
- Plans or surveys, as-built plans
- Historical documents, archives
- Conformity documents on normative and regulatory frameworks in force (performance, etc.)
- Environmental (LCA)/economic/technical studies
- (Maintenance) logbooks, maintenance contracts

g. Suggested applications

This section can be used to suggest possible reuse applications and related concerns, such as:

- Suggested reuse applications and illustrations (e.g. pictures/technical details). A high or effective reuse potential can be demonstrated by making reference to other projects in which a similar item could be successfully reused. A collection of projects can be found on different sources online, in particular: the Examples section on Opalis.eu, in the Guide bâtiment durable (Brussels Environment), on Bellastock's website, etc.
- Potential complementary studies required, to pursue (feasibility studies, technical tests, etc.)
- Possible preparation/re-installation recommendations

²⁷ In fine, this will not affect the realization of an audit of the hazardous substances or a pre-demolition audit conducted by an expert.

h. Others

Any relevant information found, in the form of pictures, attachments or written indications.

5.3.3.2 How to collect the data: further studies

To add all these layers of information, various additional research may be required. These additional studies can refer to different aspects.

Dismantling tests

How elements are fixed to the building influences their reusability. Testing the deconstruction process is a good way to check whether elements can be easily removed, by which means, where and with which loss rate. It can also be useful to clean the samples, in order to verify that their condition has not been altered during the process.

Examples



These heavy Belgian blue limestone slabs were removed from the façade cladding to be reused elsewhere in this renovation project. Some tests were required to assess the feasibility of this operation.



Dismantling test of a wooden floor

Chemical composition/toxicity/presence of dangerous substances

The presence of hazardous substances can seriously hinder the reuse potential of a construction element. Complementary to the information provided by experts in other assessments (asbestos survey, for instance), additional tests may be required to provide specific insights regarding the reuse potential: presence of tar in the glue of a wooden floor, lead-based paints, etc. Lead, for example, can indicatively be tested on site using chemical testers. Other substances need to be identified in specialised laboratories. There, specific tests are conducted on samples carefully extracted from the building. A certified expert may be required to extract these samples.

Example



Lead Check Swabs: 'red means lead'

Technical studies

Lack of information on the technical performance of a reclaimed material may restrict its potential for reuse. Technical studies will demonstrate that these products are effectively meeting the requirements of their new intended use. This will help to remove uncertainties regarding the performances of the reclaimed products, to meet necessary or required standards, and enable companies and contracting authorities to have as much confidence in these products as 'new' products.

Depending on the importance of the technical performance assessed, the result should not always constitute a decision but an aid for the decision-maker.

The technical performances required will first be determined according to their intended (or projected) reuse destination. These performances can be divided into fundamental ones (legally required or necessary for the component to be suitable for its intended use, taking health and safety into account) and complementary ones (non-fundamental, project-specific requirements).

Following this, different approaches, which offer different degrees of accuracy, can be used to demonstrate the fitness-for-reuse of the products. Some of them may relate to the reclamation audit inasmuch as they intend to collect specific information on the products. Different means can be expected:

- Direct inspection: visual inspection or non-destructive tests conducted on-site. This inspection may consider factors such as climatic ambiance of the room (temperature, hygrometry), hints of unusual uses (occurring stresses on the elements), presence of damage, etc.
- Documentation: consultation of the technical documentation, data sheets, as-built plans, original specifications, logbooks, archives, online declaration of performances (for more recent products), etc. Conclusions can be drawn on the current performance of the product provided that the history of the element is kept in mind.
- Tests: samples of products can be tested in laboratories to determine specific performances (mechanical, chemical, etc.). Some procedures rely on statistical approaches conducted on large batches of samples, as test protocols are based on standardised production and not on a deposit. Specialised firms will be able to carry out these tests.

Some of the technical performances can be directly assessed by the owner or a non-expert. However, in most cases, technical studies require many skills depending on the variety of the performances to be verified. You can either contact a technical office specialised in this field regarding the performance(s) to be checked, or a person or company that has multiple skills and the knowledge required to conduct a complete technical study.

Example



The BedZED project (London, 2002) pioneered different approaches for assessing the performances of reclaimed products.

Reclaimed timbers, reused for structural purposes, were visually stress graded by a specialist contractor. This took place at the reclamation dealer's site¹. Similarly, reclaimed structural steel (of which about 98 tons were reused in total) was also assessed by consulting structural engineers. They proceeded with a double approach, combining thorough research into historical documentation (to obtain information on allowable stresses of beams at the origin) and careful visual inspection. In the case of reclaimed steel beams, other methods could have been used, combining non-destructive portable hardness testing with coupon tests to 'allow a satisfactory degree of confidence in the properties of the material'².

Photos: BedZED Construction material report

1 N. LAZARUS, *BedZED: Toolkit Part I. A guide to construction materials for carbon neutral developments*. BioRegional, 2002, p. 20.

2 CULLEN and ALLWOND, *Sustainable Materials with Both Eyes Open*. Cambridge: UIT Cambridge, 2012, p. 229.

Environmental impact/benefit studies

In some operations, it will be necessary to supplement the reclamation audit with information regarding the environmental impact of these operations. This information can certainly influence the decision to reclaim some products - in addition to economic or technical arguments. This is particularly applicable in projects aiming at demonstrating their efforts to lower their environmental impact or projects targeting environmental certifications (e.g. HQE, BREEAM, LEED).

These studies are usually conducted using Life-Cycle-Analysis (LCA) methods. An LCA compares different environmental impacts at all phases of the life of a material or product using different indicators such as global warming, ozone depletion, but also incoming and outgoing flow and waste flow indicators. Reusing a product is usually considered a means of bypassing the impacts linked to the production and demand of raw materials for the original product. However, the impact of the specific operations required to reclaim the product also needs to be accounted for in this assessment.

Specialised environmental offices or reuse experts shall be contacted for an environmental benefit analysis.

Economic studies

The decision for reclamation is not only a question of performances and fitness for use. Decisions for reclamation will primarily be made if it is worth pursuing from an economical perspective.

The economical balance depends on:

- The available quantity of the product
- Access to the product (demolition, dismantling...)
- The amount of product which will be usable after dismantling
- Performance proof costs
- Workload
- Logistics costs
- (Re)Installation costs (if applicable)
- The market : what's the value of the product and the new product it replaces?

In others words, the total cost of reclamation and preparation of the element (studies, dismantling, cleaning, performance tests, transportation, etc.) will be estimated and compared to the cost of a similar reuse product on the market (and/or the cost of a similar new product on the market).

Economic studies can have an implication on the decision to carry out complementary studies. Indeed, if the economic analysis proves that the reuse product cost - including test costs - is below or equivalent to the price of alternative new products, it may convince the building owner to implement these tests.

Note that the result of this studies should not always be considered a decision. Other factors, such as historical or aesthetic value, should also be taken in account.

Other studies

In some cases, it may be necessary for experts to study logistics (time, space to store, ...), procurement rules, or authenticity and historical value of the element for example.

5.3.4. Level of detail

As explained above, the elaboration of a reclamation audit is an iterative process. It starts with the collection of general information and moves towards a more detailed description of each relevant entry. The notion of 'level of detail' is used here to describe the level of details sought in listing the information.

The first version of the reclamation inventory (template 1 – see 5.3.2) usually corresponds to a low level of detail. It gives general indications on the elements at stake, their quantities and the most general observations. In certain cases, values in the inventory can be limited to estimation.

The second template usually involves a much higher level of detail (template 2 – see 5.3.3). The items are described much more comprehensively, and many other considerations are taken into account.

It is important to recall that a high LOD is not necessarily or absolutely more useful than a low LOD. The most important factor is that the LOD of a reclamation audit is sufficient to establish an accurate assessment of the reuse potential.

However, the choice can be made to accurately reflect any discrepancies between similar products (constituent material, dimensions, location, complementary technical characteristics ...) from the start to avoid subsequent iterations and related efforts.

Ultimately, the collected information needs to provide future users with all the information they may need to assess the opportunity for reusing the identified elements.

Example of an inventorying process for interior doors evolving through different levels of detail

This semi-fictional example illustrates the process of moving from a low to a high level of detail in the successive iterations of a reclamation audit. It demonstrates that each step comes with specific requirements in terms of the information to be collected.

This example relates to a batch of fire-resistant doors in a recent office building.

The **first phase of the process** consists of a quick reclamation audit on the 22nd floor of a corporate tower block.

This audit takes place just before the start of the refurbishment of this floor. In principle, all interior elements are to be evacuated but the management wishes to know whether it is worth reclaiming some of these elements. At this stage, however, they have no clear view of what they would do with them. The elements may potentially be reused on the same site for the new project, they could be sold, or be used in another ongoing operation. At this point, the management primarily wishes to have a better perspective regarding this issue but does not wish to spend too much time on it (especially if the outcomes are negative).

In the approach to establishing a quick reclamation audit, the auditor, who can be someone from within the organisation, may produce this type of inventory:

Template 1 : primary information



PRIMARY INFORMATION												
Identification		Picture	Quantity		Dimensions		Mass			Location in situ	Condition	Remark(s)
nbr.	Item name		unity	nbr.	unity	dim.	unity	nbr.	total lot			
1.1	Interior doors		pce	~100	cm	~210 x 90	/	/	/	Building A, 22 floor	ok	/

The level of information remains relatively low: a picture, an estimation of the quantity and the dimensions, and a general observation on the condition. It did not take the auditor more than a few minutes on site to collect this data. Nevertheless, these are sufficient to suggest a possible reuse potential.

Following this phase, the contracting authority asks the auditor to acquire more information on these doors. This is the second step in this scenario.

In this **second phase of the process**, the auditor spends a bit more time in the building. It allows them to refine and complete the information:

Template 1 : primary information

PRIMARY INFORMATION												
Identification		Picture	Quantity		Dimensions		Mass			Location in situ	Condition	Remark(s)
nbr.	Item name		unbr.	nbr.	unbr.	dim.	unbr.	nbr.	total lot			
1.1	Interior doors THEUMA (left opening)		pce	51	cm	211 x 92 x 3.39	kg/pce	~50	~2,500	Building A, 22 floor	A few doors have scratches on their surface	Fire-resistant 30 min.
1.2	Interior doors THEUMA (right opening)		pce	51	cm	211 x 92 x 3.39	kg/pce	~50	~2,500	Building A, 22 floor	A few doors have scratches on their surface	Fire-resistant 30 min.

The level of detail is higher. Quantities and dimensions are now much more precise. During this new walk-through, the auditor identified a few scratches on some doors. The auditor also found that the doors are fire-resistant (30 min) and discovered that some doors were right-opening and other left-opening (hence a double entry in the inventory table).

Additional desk-based research, corresponding to a **third phase**, brought even more precise indications. The auditor summarised this in the more detailed sheet (see next page).

Collecting complementary information undoubtedly requires more time. A higher level of information, however, is likely to answer more easily most of the new user's requirements and questions. Whoever will consider reusing these doors (be they salvage dealers, designers for the new project, or internal management) can now envisage an effective reuse opportunity:

- They can verify if the quantities match their needs.
- They can design the doorways according to the dimensions of these doors.
- They can budget the cost of the operations (considering, for instance, the need to change the lock or to adapt the hinges).
- They may decide whether they want to use these doors in a situation in which a fire-resistance of 30 min is mandatory or use them for lower requirements.
- Etc.

Template 2: Complementary Information

Complementary pictures



Fire-resistance and Benor certification marking

Item

Brand	Theuma
Specificity	51 right-opening + 51 left-opening (according to EN 12519:2004)
Implementation date	2012
Certification	Fire-resistance 30 minutes, Validity of Belgian ATG (ATG 2287) (see picture) applicable until 2020.
Constituent material	Core : Hardwood Finishing: Laminated with a black HPL coating Door handles: stainless steel
Condition	11 doors have minor scratches at the bottom / door handles are in perfect condition

Context

Occupation activity of the building	Occupied until three weeks ago (01/12/2019)
-------------------------------------	---

Assembly

Door frames	Possible dismantling
-------------	----------------------

Environmental benefit

Estimated carbon saving of the entire package (102 doors)	5.100 kg, equivalent to ~ 1.500 kgCO ₂ e (according to ICE DB V2.0 7 Nov. 2019)
---	--

Hazardous substances

The box may contain: an explicit warning about the product/ a colour code

Green : the element has been tested and does not contain hazardous substance	Grey : the element has not been tested but the auditor wanted to highlight a potential hazard
Red : the element has been tested and contains a hazardous substance but can eventually be reused after treatment	White : the element has not been tested and the auditor does not wish to highlight a potential hazard

Asbestos inventory: confirmed free of asbestos hinges

Additional documents

Asbestos inventory	Inventory dd. 20/11/2019
Location plan	ref. as-built plan dd. 12/05/2012
Original manufacturer's catalogue	ref. Theuma_2011

5.4 What's next?

How do you make sure the reclamation inventory reaches the right stakeholders?

There are various scenarios than can coexist:

- The demolition contractor needs to be informed on which building elements will be recovered before the actual demolition starts or which elements should be jointly dismantled with other contractors on site.
- In the case of a reuse for a specific project, the architects and/or the contractor for the future project (if known) can be contacted to discuss the possibilities for (re)using some products. They will validate (or invalidate) the potential for reusing it for a specific future project. They can also ask for more details or have specific requirements before continuing the process. If the interest is shared, they can even consider site-to-site reuse by checking a possible ongoing project which could recover some of the identified items²⁸. Contractors and contracting authorities are beginning to form the habit of circulating a list of reclaimed products within their own organisation which can also lead to the effective reuse of the elements.
- In the case of a resale (or a donation), the approach varies according to the nature of the contracting authority:
 - A private operator may contact reclamation dealers. They can also advertise the reclamation inventory on online platforms or contact local communities.
 - A public operator is subject to public procurement legislation. In this framework, the award of public contracts and concessions is subject to advertising and competitive tendering rules. The audit can:
 - Be annexed to the demolition contract to require the demolition contractor (through a best-efforts obligation, for instance) to carefully dismantle some elements and find them a new destination. In this case, the building owner doesn't have to add new contracts.
 - Support a tender for deconstruction²⁹.

About logistics

The auditor can anticipate some factors when conducting the audit (see 5.2.2 Following general criteria). If the auditor is not the contractor or a reclamation dealer, it can be dangerous to consider the logistics by alone because they may have some misconceptions about what is easily manageable and what is not. They can then contact a deconstruction contractor or a trader to manage this aspect.

28 Site-to-site reuse: from partition walls to insulation panels

29 To help public building commissioners, Rotor has developed a Vade Mecum to be used on "How to extract reclaimable construction products". In this Vade Mecum, there is an explanation on how to organise the disassembly and acquisition of reusable products by an interested acquirer before or during the public works contract. <https://opalis.eu>

Documents such as "Guide Pratique sur le Réemploi/Réutilisation des matériaux de construction" developed by Ressources asbl, CCW and CCB-C can also be consulted. http://www.confederationconstruction.be/Portals/28/cellule%20environnement/guidesdocumentsutuels/Guide%20r%C3%A9emploi_r%C3%A9utilisation%20des%20mat%C3%A9riaux%20de%20construction.pdf

Annexes

Annex 1: Glossary

Cascading (re) use	Reusing a construction material or product for an application with lower technical requirements than the original one.
Deconstruction	<p>Taking a building apart normally using the reverse of the methods by which it was built.</p> <p>In the UK, deconstruction used to refer to the action of taking down demountable structures (such as music festival stages). The term has been adopted in the 1980s by salvage dealers in the USA to describe their careful alternative to conventional demolition.</p> <p>The terms deconstruction and disassembly are now in use in the UK by academics institutions and construction professionals, and although the salvage and demolition trades still use the term 'dismantle', the term 'deconstruct' is well understood.</p>
Demolition	<p>The process or action of removing or clearing a building or part of a building, usually using heavy machinery, often by the most expedient means.</p> <p>Demolition often includes a soft strip, which is the segregation of materials intended to be recycled or reused.</p> <p>Demolition is undertaken by demolition contractors.</p>
Dismantling	The process or action of carefully taking apart, during a demolition, a building to save reusable elements.
Reclamation audit	<p>The action of undertaking an assessment of potentially reusable building materials and products, after the decision has been taken to demolish a building.</p> <p>The audit results in the reclamation inventory, which is a list of reclaimable products or materials.</p> <p>The level of detail may vary but will normally include factors such as quantity, dimensions, constituent material, and condition. A reclamation audit may also assess comparative carbon content, ease of removal, technical characteristics, and general reclamation advice.</p>
Reclaimed building material or product	Material and product derived from reclamation.

Reclamation

To carefully salvage, deconstruct, dismantle, demolish or otherwise take apart a building for the purpose of maximising the amount of material saved for reuse.

This activity encompasses the purchase, salvage, processing, storage and sale of reusable materials and products.

Reclamation dealer

see 'Salvage dealer'

Reclamation sector

Refers to a narrow segment of the reuse sector. It includes mainly salvage dealers and dismantling contractors, runners, restorers.

Reuse

Another use, at the end of its current life, of a construction product or material.

Ideally, the installation of the reused material or product should be reversible, allowing for future uses of the same product.

Reuse includes handmade and low-tech recrafting, repurposing or remanufacturing, such as the sawing of reclaimed timber beams into planks for use as flooring, or in making new furniture, for example.



Reclaimed bricks



Reused bricks

Reuse sector

Refers to all parties actively involved in reuse including clients, the reclamation sector, construction professionals, specifiers and end-users. It may also include interested parties such as environmental and building conservation organisations, regulators, government and local authorities.

Salvage

Saving elements of a building, construction or landscape for the purpose of reuse.

Synonym: reclamation, although salvage usually refers to more modern materials and products.

- Salvage dealer** Economical actor who acquires and sells reclaimed construction elements.
- Most salvage or reclamation dealers are equipped to undertake specific operations to prepare reclaimed construction elements for reuse. This involves, for example, sorting, cleaning, dimensioning, documenting, advertising and shipping. Some salvage or reclamation dealers combine the sale of reclaimed products with an activity as deconstructors or demolition contractors.
- Synonym: reclamation dealer.
- Same-site reuse** Use of an element dismantled from a building in a new construction or renovation project happening on the same site. It may require storage, either on site or elsewhere.
- The expression *in situ reuse* is used in France and Belgium.
- Site-to-site reuse** Expression forged as part of the FCRBE project to refer to situations in which a reclaimed material or product travels directly from dismantling to end-user, avoiding the stockholding (dealer) network.

Actors

- Architects** Refers here to the persons or organisation contracted to design a new construction project for the client. Architects can team up with other actors (such as structural engineers, energy experts...) to carry out their mission.
- Building owners** (or clients) Refer here to the persons or organisations which own the building and/or are managing the financial resources for conducting construction and demolition operations.
- Reclamation or salvage dealers** Refers here to companies that are specialised in the reclamation of construction products. They source construction products released from demolition works, process and store them, before putting them back on the market. Some dealers are only trading very specific materials, while others are much more diversified. They usually provide a range of services that facilitate the reuse of the products.
- Reuse expert** Refers here to a relatively new professional profile that offers assistance for achieving reuse ambitions (which are often coupled with a larger view on circular economy). Depending on the missions at stake, they can be contracted directly by the client or team up with the architects (in the context of an architectural contest, for instance). In some cases, these reuse assistants are former architects who have built up such specific know-how on reuse that it becomes a new service which they are able to provide.

Annex 2: Templates

This annex illustrates the templates available in excel format, which are referred to in the manual: (see 5.3 What information should be collected and how should it be collected in an inventory?).

- **Template 1** - Primary information (see 5.3.2)
 - Prerequisite: general context information (see 5.3.2.1)
 - Primary data (see 5.3.2.2)
- **Template 2** - Complementary information (see 5.3.3)

This standard document can be used as a ready-to-use model or as a source of inspiration to be adapted according to your practices and characteristics.

RECLAMATION INVENTORY

GENERAL CONTEXT INFORMATION

REFERENCE DATE INVENTORY DATE OF THE SITE VISIT(S)	
--	--

INVENTORY DOCUMENT	Annexes to PRIMARY DATA
--------------------	-------------------------

CONTRACTING AUTHORITY	name address tel/ mail
-----------------------	------------------------------

AUDITOR INFORMATION	name address tel/ mail (contact person)
---------------------	---

AUDITED BUILDING (or part of -)	name address tel/ mail (contact in situ)
----------------------------------	--

BUILDING OWNER INFORMATION	name address tel/ mail (contact person)
----------------------------	---

BUILDING INFORMATION	e.g. type of building, location, etc
----------------------	--------------------------------------

AUDITS/ INVENTORIES	Did you consult any type of audits/ inventories while doing this reclamation inventory? If yes, which one(s)?		
	<table border="1"> <tr> <td>NO</td> </tr> <tr> <td>YES</td> </tr> </table>	NO	YES
NO			
YES			

PLANNING OF THE PROJECT ACTIVITIES/ STAGE	
--	--

PRIMARY INFORMATION												
Identification	Picture	Quantity		Dimensions		Mass			Location in situ	Condition	Remark(s)	
		unity	nbr.	unity	dim.	unity	nbr.	total lot				
nbr.	item name											

Template 2: Complementary Information

This standard document can be used as a ready-to-use model or as a source of inspiration to be adapted according to your practices and characteristics.

Item identification	
nbr.	Item name

COMPLEMENTARY INFORMATION

Complementary pictures

Item data

Text box to unhide

Context data

Text box to unhide

Assembly data

Text box to unhide

Potential environmental benefit

Text box to unhide

Hazardous substances

the box may contain: an explicit warning about the product/ a colour code

Green : the element has been tested and does not contain hazardous substance

Grey: the element has not been tested but the auditor wanted to highlight a potential hazard

Red : the element has been tested and contain an hazardous substance but can eventually be reuse after treatment.

White: the element has not been tested and the auditor does not wish to highlight a potential hazard

the element has not been tested and the auditor does not wish to highlight a potential hazard (default settings)

the element has not been tested and the auditor does not wish to highlight a potential hazard (default settings)

the element has not been tested and the auditor does not wish to highlight a potential hazard (default settings)

the element has not been tested and the auditor does not wish to highlight a potential hazard (default settings)

Additional documents

Text box to unhide

Suggested applications

Text box to unhide

Others

Text box to unhide

Provisional conclusion regarding the reuse potential of the product

Text box

Annex 3: Commonly reclaimed construction products

The following **commonly reclaimed products**³⁰ have received significant positive feedback from actors reusing them in the building field, as reflected by market resale potential and specific past project opportunities. Where possible, they are considered to have a high potential for reuse.

Experience shows the existence of **common barriers** within the meaning of negative indicators, frequently encountered and affecting a reclamation (extraction) decision. They are included in the list below.

The following sources are relevant to applications, technical concerns, as well as regional complementary specificities:

- Opalis.eu
- Wrap. Practical solutions for sustainable construction. Reclaimed building products guide (UK situation)

Furthermore, it should be noted that, where possible, the reclamation of demolition materials for reuse on-site constitutes a *quick win* as it has several advantages³¹.

1. Solid bricks



Material used: (local) clay

Commonly reclaimed: solid bricks from brick walls bound with a lime-based mortar (or other soft mortars: clay, ash, etc.)

Common barriers:

- Extruded bricks
- Brick from walls bound with a cement mortar whose resistance compromises the cleaning of bricks
- Chimney bricks affected by soot
- Bricks that don't reach quality standards set by resellers

30 All pictures are from Opalis.eu

31 <http://www.wrap.org.uk/sites/files/wrap/Reclaimed%20building%20products%20guide.pdf> (p. 14).

2. Roof tiles / slates



Material used:

- Roof tiles: (local) clay (some available in concrete)
- Slates: slate from local slate mines

Commonly reclaimed:

- Hand or machine-made tiles and slates

3. Timber

General remark: Experience shows that reclaimed timber, by its very nature, can easily be worked and transformed, allowing it to serve various functions.

3.1. Wood flooring

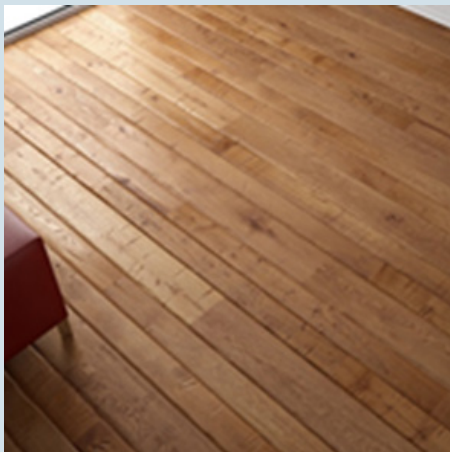

Material used: predominantly oak and pine, although other species are used (beech, chestnut, elm, maple, etc.)

Commonly reclaimed:

- Nailed or floating installations
- Block flooring (but not as widely reclaimed as timber floorboards)

Common barriers:

- Floors laid on black bituminous glue with the presence of tar in the glue
- Floors treated with paints which are composed of heavy metals, such as lead
- Block flooring fixed with concrete

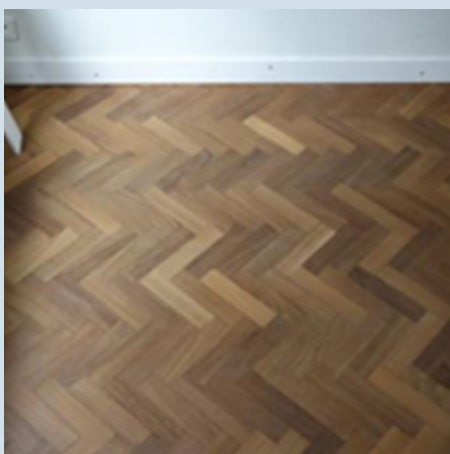

3.2. Timber beams and studwork



Material used: predominantly softwood (pine, pitch pine)

Commonly reclaimed:

- Sections of reused wood that are sought after purely for their technical qualities, and which are generally sold as an alternative - more ecological or less expensive - to the equivalent new product
- Old beams, often from century-old buildings
- Where possible, most common types are beams, joists and structural elements from the floor or roof structure, in most standard sizes, used for wall to wall, wall to beam or beam to beam horizontal supporting elements to support a ceiling, roof or floor



Common barriers:

- Timber elements that have undergone treatments such as flame/fire retardant or fungicide
- Elements that have suffered alterations through humidity, bugs, fungus or any other factor that may affect their quality

3.3 Cladding

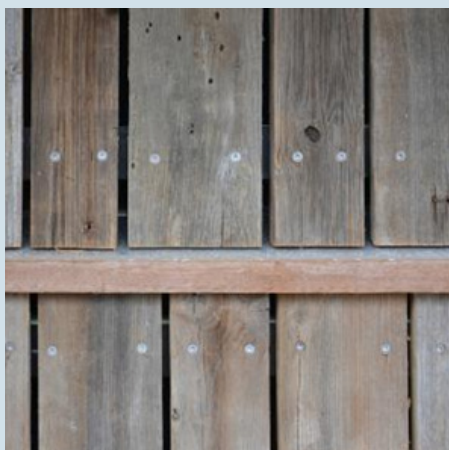

Material used: various type of wood

Commonly reclaimed:

- Exterior cladding and interior panelling from a variety of sources
- Panels based on reconstituted wood, which are also suitable for cladding or panelling applications

Common barriers:

- Glued cladding and panelling

4. Floor and wall tiles



Material used: ceramic, cement, terracotta

Commonly reclaimed:

- Ceramic or plain cement tiles (of a rather square format, with patterns)
- Plain terracotta tiles (in square, rectangular or hexagonal format) which retain the terracotta colour

Common barriers:

- Glued installation or bound with highly resistant mortars that would make them too difficult to dismantle or to clean back to a state where they can be easily re-installed

5. Structural steel



Material used: structural steel

General remark: Although, where possible, reclaimed structural steel can be considered a cost saving product, it is not one of the most commonly traded products as these materials are easily and cheaply sold for recycling purposes, and because their reuse for structural purposes may involve issues of structural stability and human safety, which requires sufficient evaluation and responsibility on the part of the actors involved in a construction project.

Common barriers:

- Elements that have undergone treatments composed of heavy metals such as paint, lacquer, various industrial materials

6. Doors

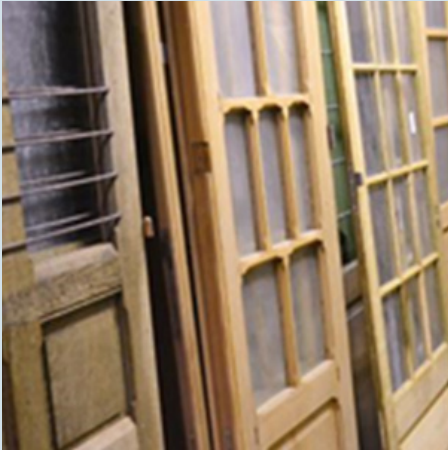

Material used: timber, glass, composites

Commonly reclaimed:

- Standard dimensions
- Old solid wood interior doors
- Contemporary doors (PVC doors, lightweight panels, etc.)
- Where possible, recent interior glass doors and, more exceptionally, fire door sets from more contemporary buildings

Common barriers:

- Asbestos sealants and joint components (more commonly found in fire doors and frame plates)
- To reuse fire-resisting doors, you need to find proper fire-resisting frames



7. Double glazed window frames



Material used: wood, PVC or aluminium

Commonly reclaimed:

- Standard dimensions
- Old wooden window frames, some with stained glass windows
- Frames from the demolition of more recent buildings

Common barriers:

- Asbestos sealants and joint components (more commonly found in frame plates)
- Low performance and/or the absence of documentation on performance

8. Cast iron radiators



Material used: cast-iron

Commonly reclaimed: cast-iron radiators, their valves and accessories

Common barriers:

- Asbestos sealants and joint components, and entities that have been subjected to heavy metal paints (lead, etc.)
- Low performance
- Some models are more sought after than others *e.g. those with feet are more valuable than hanging ones*
- Some items can be heavy and large and difficult to extract from a building

9. Luminaries



Commonly reclaimed:

- Led-based luminaries
- Old luminaries

Common barriers:

- Obsolete nature due to new electric norms and regulations limiting possible uses
- Outdated design lacking the attractiveness required to find new users
- Outperformed by new equipment

10. Sanitary equipment

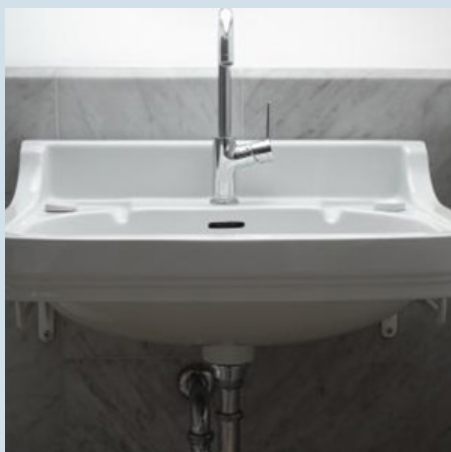

Material used: ceramic, inox and sanitary grade acrylic

Commonly reclaimed:

- Baths and wash basins, of various styles and periods
- Sinks, drains, urinals and toilet bowls
- Sanitary equipment with a particular aesthetic interest

Common barriers:

- Outdated sanitary equipment
- Some items may require in-depth cleaning in order to be reused

11. Stone thresholds, steps, walling and pavements



Material used: variety of stones (blue stone/burgundy stone/sandstone/marble/limestone/sandstone/gritstone/York stone [pavement])

Commonly reclaimed:

- Stone thresholds, steps, walling and pavement which can be easily deconstructed

Common barriers:

- Stonework fixed with mortar
- Some stones need heavy professional machines in order to be retrieved



12. Road components: pavers and setts, kerbs and concrete paving slabs



Material used: variety of road stones: granite/sandstone/concrete/porphyry/blue stone/terracotta ('klinkers')

Commonly reclaimed:

- Street paving stones
- Concrete paving slabs
- Sidewalk paving stones, known as 'platines'. They are characterised by a square surface and reduced height
- Mosaic paving stones: smaller in size and almost cubic in shape
- Pavement kerbs
- Terracotta paving stones, known as 'klinkers'

Common barriers:

- Elements bedded on a cement-based mortar



13. Architectural salvage



Commonly reclaimed:

- Old staircases and portals
- Chimney mantels
- Old beams, often from century-old buildings etc.
- Old wooden window frames, some with stained glass windows
- Ironwork: balustrades, fences, gates, etc.
- Etc.

Common barriers:

- Heavy metal sealants and joint components (such as lead)
- Low performance and/or the absence of documentation on performance



If 'commonly reclaimed' infers that a stable and extended market exists, sometimes this is not the case.

The following products, more specifically, relate to elements from a project opportunity, consisting of newcomers on the market, or existing in a limited specialised or regional market.

14. Technical installations



Commonly reclaimed:

- Complete technical equipment from industrial buildings and large buildings such as heat pumps, emergency generators or compressors

Common barriers:

- The non-recoverable nature of elements affected by polychlorinated biphenyls (heat transfer fluid, accumulators...), mineral oils and lubricants
- Obsolete nature due to new norms and regulations limiting possible uses
- Low performance and/or the absence of documentation on performance
- Some equipment might still approach the actual end of their life
- Need to find specialists to get an informed opinion and logistical know-how on how to dismantle, transport and reassemble them



15. Raised floors and their support systems

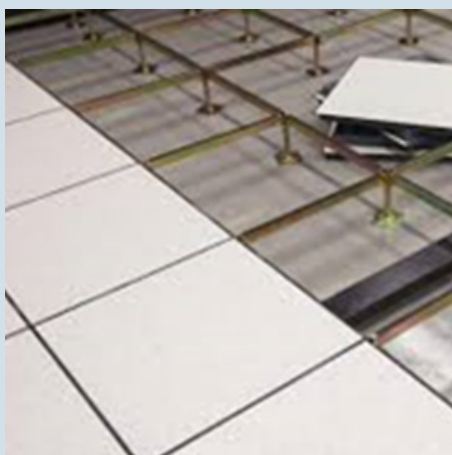

Material used: mixed materials. Predominantly based on agglomerated wood panels

Commonly reclaimed: Modular tiles and pedestals

16. Rolls or panels of insulation



Material used: mineral wool : rock wool

Common barriers:

- Low performance and/or the absence of documentation on performance
- Material being in poor condition as it can easily deteriorate

17. Entire building structures or specific entities



Material used: various: frame: steel, cladding: steel, aluminium, composite, etc.

Commonly reclaimed: most notably, units from the industrial and agricultural sector and from different eras, which, where possible, can be reused as follows:

- Portal frame steel structures (warehouses, etc.)
- Greenhouses, summerhouses
- Sheds
- Fire escape staircase units
- Mezzanine entities

Common barriers:

- The presence of elements that have undergone treatments composed of heavy metals such as paint, lacquer, various industrial materials.

Equally, items which are rarely reclaimed may occasionally have a very good market.

This is not further developed here.

Annex 4: Examples of reuse operations

This annex complements Chapter 5 and presents examples of reuse operations.

- The first chapter illustrates how a series of criteria can motivate/foster the reuse of materials.
- The second chapter illustrates examples which, instead of responding to an established demand, demonstrate that a project can create an opportunity for reuse.

4.1 Examples with influence criteria fostering a reclamation decision

These examples present which (and how) influence criteria presented in Chapter 5.1 can foster a reclamation decision, sometimes even when negative hints have also been detected.

4.1.1 Reclamation of Carrara marble slabs in a Brussels train station, Brussels.

In this example, it was a combination of different factors that made the reclamation of Carrara marble slabs successful.

- ✓ This material was present in a **large quantity** in a Brussels train station.
- ✓ The elements were relatively **homogeneous** in terms of dimensions.
- ✓ It was **not too complicated to dismantle** them and, although **not in perfect condition**, they could be cleaned (first, rough cleaning took place on site, followed by thorough cleaning at the reclamation dealer's premises).
- ✓ **Logistics** were manageable and the use of a small crane facilitated the handling.
- ✓ All in all, the **cost** of these operations did not prevent these elements from being sold at an advantageous price to clients. The **iconic value** of their original location made them even more interesting to new users.

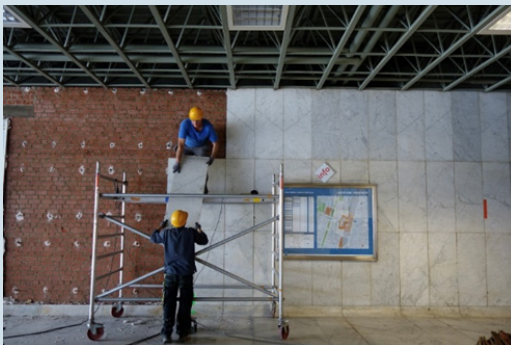

Images: courtesy of Rotor

4.1.2 Reclamation of single glazed windows despite some negative hints, France.

For the construction of the head office of an urban farming cooperative, the architect in charge chose to design a bioclimatic façade with reclaimed elements. A reuse assistant was appointed to scout for materials and suggested single glazed wooden windows from a social housing project that was going to be demolished 4 km away. In close collaboration, the architect and its reuse assistance adapted the design of the façade based upon the reclaimable windows.

- ✓ An agreement was reached with the social landlords, for whom an **economic balance** was respected between the careful dismantling of the windows and the costs for land filling. The reclamation operation included a processing step for adapting the dimensions of the wooden frames.

In conclusion, this operation was made possible because materials:

- ✓ Were available in **large quantities, very homogeneous**.
- ✓ Had a **facility for dismantling** and **manageable logistics** (containers were used for transport).

The integration of 50 year-old wooden windows was possible even though:

- X There was **no market** for reclaimed single glazed windows.
- X The elements had a **very low performance** and were **not adapted to new norms and regulations**.
- X **No documentation** was available.
- X Moreover, the operation was possible despite the presence of **polluting substances**: the wooden frame was covered with lead paint that was properly removed by the carpenter during the processing phase.

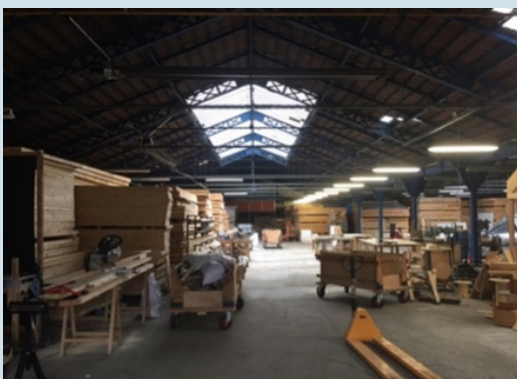

Images: courtesy of Bellastock

4.1.3 Reclamation of landing doors. Construction of a day care centre, Paris.

This operation illustrates how a key public owner can take advantage of its own building stock to commit to its circular economy ambitions. For the construction of this new day care centre in Paris, Paris (RIVP) estate agency used the reclamation audit of one of its soon-to-be renovated buildings just across the street.

- ✓ The **quality** and **homogeneity** of the 600 landing doors coming out of this building inspired the architect to use them as part of a double-skin façade for the new building.
- ✓ The landing doors were **not too complicated to dismantle**.
- ✓ The carpenter in charge of processing was able to provide a quick evaluation of the wood **quality** and **took responsibility** for the final product warranties.
- ✓ All in all, the **cost** of this operation was **lower** than using new local treated wood or new exotic wood.



Images: courtesy of Bellastock

4.1.4 Reclamation of bricks. Renovation of former foundry “Tour à plomb”, Brussels.

This example highlights the collection of positive influence criteria in the reclamation decision of nearly 60 m³ (138 t) of bricks. These were subsequently reused on site.

- ✓ The reclaimed bricks were originally put together using a lime-based mortar. The **dismantling** was facilitated by the investment in an appropriate tool and related training for the workers to enable deconstruction without altering its mechanical performances and aesthetic aspect.
 - ✓ Site management ensured **manageable logistics**. The dismantled bricks were easy to handle and could be transported, stored, processed, and re-installed without damaging the original quality. As the construction site itself lacked storage space, solutions were found on the contractor’s property.
 - ✓ The identification of the bricks to be reclaimed during the pre-demolition inventory was notably based on the positive assessment of their **condition** and on the consideration of a reasonable and cost-effective reuse process. The quantity of deconstructed bricks forecasted met the total demand for bricks needed in the new project. This **quantity** justified a reclamation operation and the deployment of specific measures (logistics, tools, training, etc.).
 - ✓ The reclamation operation was based on a **positive environmental assessment**: in return for the additional investment, there was a social (local manpower and handling) and ecological benefit (no extraction of raw material and production).
 - ✓ From an **economic point of view**, the cost for applying reclaimed bricks ultimately turned out to be equivalent as those of new bricks. The designers chose to take advantage of the aesthetics of these bricks, which were left visible in the project, resulting in savings on plastering costs.
 - ✓ In addition, solid brick bound with a lime-based mortar is a **commonly reclaimed product**.
- Overall, the motivation to reuse the bricks was based on **financial, aesthetic, ethical, as well as heritage values**.

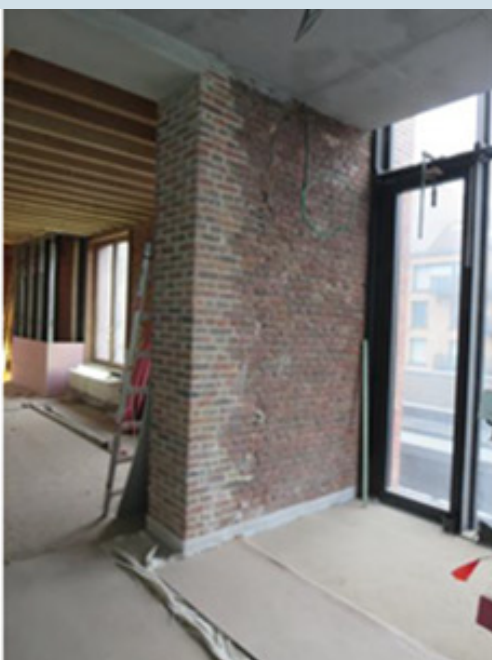

Images: <https://www.circulareconomy.brussels/> and <https://opalis.eu/fr/projets/renovation-de-la-tour-plomb>

4.1.5 Reclamation of tiles. Tivoli green city, Brussels.

This example specifically illustrates the deployment of **appropriate logistics** which was facilitated by several factors:

- ✓ First, small crates were used. It allowed reclaimed ceramic tiles to be handled easily.
- ✓ This kind of crate is handy enough to be lifted manually by the deconstruction workers and can then be easily stacked onto pallets.
- ✓ A large courtyard also provided enough space to install the lift, prepare the pallets and load the trucks. This free space contributed significantly to the logistics of this operation.
- ✓ The existence of a local salvage dealer that had developed a specific installation to clean this type of tiles facilitated the processing of the materials. This operator also took in charge the temporary storage of the tiles.



Images: courtesy of Rotor

4.2 Examples of projects that created opportunities for reuse

In case of higher ambitions and with the help of an exhaustive audit (complemented by technical, environmental, economic studies), the operation is able to go further than simply responding to an established demand.

The following examples demonstrate how a project can create new opportunities for reuse.

4.2.1 Glue-laminated beams reused on the Standaert site, Belgium.

For their conversion project from a former DIY store into a community meeting place, the presence of a structure in glue-laminated wood on-site was, from the outset, considered an opportunity by the architects to design a type of courtyard in their future project. If the project had failed to pass a custom-made conception phase, the beams would likely have been disposed of in a wood container and incinerated as these elements are not commonly found by resellers.



Images: <https://opalis.eu/fr/projets/poutres-en-lamelle-colle-reutilisees-sur-le-site-standaert>, courtesy of ae-architecten, Rotor and Carton123.

4.2.2 'Winnipeg Folk Festival' centre. A radically converted hangar, Canada.

This 5-day music festival takes place every year. The building commissioner gave the architects the task of building a de-constructible big kitchen for the festival. As he wanted to leave no trace after the structure was dismantled (+ environmental motivations), the design team decided to use reclaimed structural elements from a soon-to-be demolished warehouse not far from the location. The project team used these elements, plus others, such as some electricity poles or reclaimed wood, to build the structure. To manage to design the project around existing elements, the design team had to inventory all the available beams in the warehouses slated for demolition. They modeled quickly these elements and explored different spatial solutions. In this case, the 'reclamation inventory' consisted mainly in modelling quantities and geometries. Finally, to confirm the reuse potential of the structural elements, a stability engineering office had to verify their mechanical properties and the compatibility of the elements with the proposed structure.

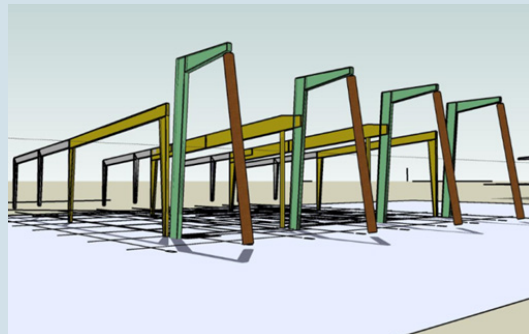

Images: courtesy of Monteyne Architecture Works Inc.

4.2.3 The Super Circular Estate project and its 3 pilot housing units, The Netherlands.

Some projects may even begin to experiment with new practices and new solutions to reveal innovative strategies and serve as an example to others. This kind of operation will demand more in-depth studies to assess the operation's feasibility.

This project aimed to reuse, repair and recycle 100% of the materials and components salvaged from an outdated 10-storey social housing building. It experimented with innovative reuse techniques, (de)construction methods (while assessing their **environmental and economic viability**) and built 3 housing units using the reclaimed products (reusing 75 to 100% [in kg] of its materials), and later 12 more apartments.

The project partners (with the help of the demolition contractor) expanded a pre-demolition audit including a **reclamation audit**. They developed a material database: an **inventory** (see picture below) to help provide them with an overview of available products and to organise the future 16 "material streams".

For example, load bearing elements, windows, doors, façades will be used for the construction of the houses and other streams will be put into the internal databases or on a second-hand materials web shop.

The inventory contained data such as quantities, weight, material composition or embodied energy and embodied CO2.

During the preliminary and definitive design phases, samples of products were tested to confirm their reuse potential and to classify them into three categories that indicate whether they are easy to recover without damaging them. These studies consisted of **technical studies**: visual examination and tests by engineers and contractors, an **asbestos survey** and **dismantling tests**.

There was also an evaluation on whether the elements should be reused as a whole or dismantled into their components³². Each of these reuse options impacted the logistics activities and time, costs, as well as related CO2 emissions required. The impacts of these different options were evaluated through **economic** and **environmental studies** during the project.

32 "For example, some parts of the building can be cut out as 3D units and directly reused in new construction, or window frames can be upgraded and reused on a component level after refurbishment. After being recovered, window frames will be refurbished by extracting asbestos from the frame and reinforcing the frame with a new piece of wood. This would create a functional frame which can be reused again and again" from https://www.uia-initiative.eu/sites/default/files/2019-05/Kerkrade_Super%20Circular%20Estate_Journal%202.pdf



Figure 3a - Examples of harvested materials from the 10-story housing block (on building, product and material level) to be used in new construction (Dusseldorf 2019).

	A	B	D	E	F	G	H	I	J	M	N
	Code 01432016462TM	material	quantity	quantity (kg)	source	source	source	source	source	ee total (MJ)	CO2 total (kg)
	01432026462TM 01432036462TM	copper, 12 mm copper 10 mm steel (88.9 x 3.25mm) copper, 10mm PVC, 110 mm	m1 (446/m1) m1 m1, 6.81kg/m1 m per working, 10 m1 1075.84	1104.4 1900.08 378 1075.84	inventory Breme inventory Dussel inventory Breme inventory Dussel	42 ICE 2011 42 ICE 2011 19.8 ICE 2011 87 ICE 2011 67.5 ICE 2011	2.6 ICE 2011 2.6 ICE 2011 1.37 ICE 2011 3.65 ICE 2001 2.56 ICE 2011	0.163 ICE 2011 0.163 ICE 2011 1.31 ICE 2011	46.384.80 79.803.36 3.775.46 21.846.00 72.619.20	2.871.44 4.940.21 261.23 1.379.70 2.754.15	
1	01433026462TM	PVC, 110 mm	m1, 1.64kg/m1	1558	inventory Breme	67.5 ICE 2011	2.56 ICE 2011	0.163 ICE 2011	105.165.00	3.988.48	
2	02000016462TM	concrete RC32/40	m3	1192770	inventory Dussel	1.03 ICE 2011	0.163 ICE 2011	1.228.953.10	182.493.81		
3	02000026462TM	steel	kg	18270	inventory Dussel	17.4 ICE 2011	1.31 ICE 2011	317.898.00	23.933.70		
4	02127036462TM	steel per m3	m3	504985	inventory Dussel	1.03 ICE 2011	0.163 ICE 2011	820.134.85	77.282.71		
5	02133026462TM	laminated veneer timber 18 mm, 1	m2	77385	inventory Dussel	17.4 ICE 2011	1.31 ICE 2011	1.346.499.00	101.374.35		
6	02000046462TM	stainless steel	m2	7740	inventory Dussel	9.5 ICE 2011	0.63 ICE 2011	73.530.00	4.876.20		
7	03000016462TM	asbestos kit	m1 (50 mm1); (16.6075	inventory Breme	7.4 ICE 2011	7.4 ICE 2011	122.9	0		
8	03000026462TM	stainless steel	pieces (250 gripi	107.75	inventory Breme	56.7 ICE 2011	6.15 ICE 2011	6.109.43	662.66		
9	03000036462TM	stainless steel	pieces (250 gripi	122	inventory Breme	56.7 ICE 2011	6.15 ICE 2011	6.917.40	760.3		
10	03000046462TM	aluminum	pieces (2kg/proc	362	inventory Breme	155 ICE 2011	8.24 ICE 2011	54.560.00	2.900.48		
11	03000056462TM	maistic sealant	m1 (50mm1); (0	75	inventory Breme	131 ICE 2011	6.15 ICE 2011	2.489.00	0		
12	03000066462TM	stainless steel	pieces (250 gripi	75	inventory Breme	56.7 ICE 2011	6.15 ICE 2011	4.252.90	461.25		
13	03000076462TM	asbestos plates 5 mm	m2 (12 1kg/m2) 75	171323.9	inventory Breme	7.4 ICE 2011	1.561983471	1.267.796.86	287.605.10		
14	03000086462TM	asbestos plates	m2 (12.1 kg/m2	9282.8	inventory Breme	7.4 ICE 2011	1.561983471	68.766.72	14.515.20		
15	03000096462TM	single pane glazing (10 kg/m2)	m2	2020	inventory Breme	15 ICE 2011	0.86 ICE 2011	35.305.00	1.737.30		
16	0300106462TM	maistic sealant	m1 (50mm1); (0	14	inventory Breme	131 ICE 2011	6.15 ICE 2011	1.834.00	0		
17	03032016462TM	sawn softwood (pine) (70x45 mm)	m1 = 38.4 m3 (4	18124	inventory Dussel	7.4 ICE 2011	0.58 ICE 2011	134.117.60	10.511.62		
18	03032026462TM	sawn softwood (pine) (4.8 m1 per	pieces (7.4 m3);	3404	inventory Dussel	7.4 ICE 2011	0.58 ICE 2011	25.189.60	1.974.32		
19	03033016462TM	sawn hardwood meranti 4.8m1 pe	pieces (3.3 m3);	2438	inventory Dussel	10.4 ICE 2011	0.86 ICE 2011	25.355.20	2.096.68		
20	030448462TM	aluminum 20 kg aluminum	pieces	2000	inventory Dussel	155 ICE 2011	8.24 ICE 2011	310.000.00	16.480.00		
21	03062016462TM	18 mm meranti hardwood wooden steel, 2	pieces (640 kg/m3	23.92	inventory Breme	10.4 ICE 2011	0.86 ICE 2011	269.97	22.29		
22	03062026462TM	18 mm meranti hardwood wooden steel, 2	pieces (640 kg/m3	2496	inventory Dussel	25.1 ICE 2011	1.55 ICE 2011	62.649.60	3.868.80		
23	03063016462TM	mm plaatstaal 2x2 m steel, 5 mm 1x2 m	pieces (40kg/m2	400	inventory Dussel	25.1 ICE 2011	1.55 ICE 2011	10.040.00	620		
24	03063026462TM	stainless steel	pieces (500 gripi	7.5	inventory Breme	56.7 ICE 2011	6.15 ICE 2011	425.25	46.13		
25	03063036462TM	wood stopp, hardboard met hong	pieces, 10.5 gripi	10899	inventory Breme	7.4 ICE 2011 (sawm	4.39047619	80.652.80	47.851.80		
26	03063046462TM	stainless steel hinges	pieces (250 gripi	757.75	inventory Breme	56.7 ICE 2011	6.15 ICE 2011	42.964.43	3.326.88		
27	03231016462TM	concrete RC32/40	m3	58564.55	inventory Dussel	1.03 ICE 2011	0.163 ICE 2011	60.321.49	8.960.38		
28	03231026462TM	steel	897.05	897.05	inventory Dussel	17.4 ICE 2011	1.31 ICE 2011	15.606.67	1.175.14		
29	032378462TM	steel HEB 140, lengte 1.8 m, gew	pieces	270	inventory Dussel	20.1 ICE 2011	1.37 ICE 2011	5.427.00	369.9		
30	03251016462TM	sawn softwood pine (120x40mm)	m1 (134 m3);(46	61.64	inventory Dussel	7.4 ICE 2011	0.58 ICE 2011	456.14	35.75		
31	03251026462TM	aluminum bars, 5 mm, 12.5 cm in	m2 (8m1m2); 0	165.2	inventory Dussel	154 ICE 2011	8.16 ICE 2011	28.440.80	1.348.03		

Images: https://www.uia-initiative.eu/sites/default/files/2019-05/Kerkrade_Super%20Circular%20Estate_Journal%202.pdf, https://www.uia-initiative.eu/sites/default/files/2019-02/Kerkrade_Journal.pdf and <https://www.superlocal.eu/>

Annex 5: How to take reclamation picture

A large part of the reclamation audit consists of taking pictures of the building materials and products likely to be reused. These pictures are resourceful for conducting desk-based research into the audit. They also act as a means of illustrating the reclamation inventory. All in all, it is a very convenient way of conveying a great deal of useful information in a relatively easy manner.

This tutorial provides a few recommendations on how to take useful pictures for reclamation audits.

1. The camera

- a. About the camera
- b. Setting up the camera

2. Material and context

- a. Object preparation
- b. Surrounding area
- c. Context

3. The picture

- a. Shooting angles
- b. Focus
- c. Straight picture
- d. Lighting
- e. Main picture

4. Additional information



- a. Details
- b. Technical data

5. Examples

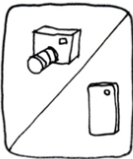
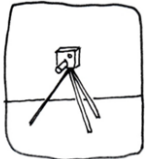

1. The camera

You can use either your mobile phone or a camera. With the right settings, both produce good images.

a. About the camera

CAMERA / MOBILE PHONE	USE A TRIPOD	CLEAN THE LENS
		
You can use a camera or your mobile phone, but make sure it takes good quality pictures.	Sometimes it is easier to use a tripod, especially in low-light conditions or if the object is relatively small.	Clean your phone/camera lens. They quickly get dirty on demolition sites. Make sure your device is clean and ready.

b. Setting up the camera

AUTOMATIC MODE	NO FILTER	QUALITY
		
In general (unless you have photography experience), the automatic mode does the job. Don't use the flash (see lighting chapter).	Don't use any filters. The picture should be as realistic as possible. When taking a picture on site, you want to minimize post-processing. If you shoot your images right the first time round, you will simplify your work afterwards.	The picture quality on your camera should not exceed 2 MB (the standard quality of a picture taken on a mobile phone is around 1.5 MB).

2. Material and context

If you are confronted with a large batch of the same element, carefully choose a representative specimen from the set (in terms of state, quality, cleanliness).

You may be conducting a reclamation audit in buildings that are empty for a long time, or even already partially in transformation. The general atmosphere can be grimy, dusty and dirty. It is important to pay particular attention to the following aspects.

a. Object preparation

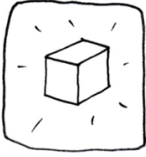
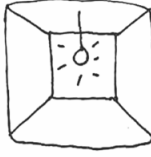
CLEANLINESS	USE
	
Clean the element, choose a sample or focus on a clean part of the material or product. Don't hesitate to sweep a small surface on the floor or to dust the surfaces to reveal the material.	Prepare the object as it is commonly used (closed doors, closed valve, light turned off/ on, hide the cables...).

b. Surrounding area

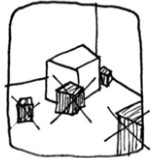
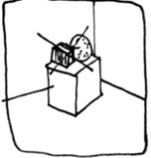
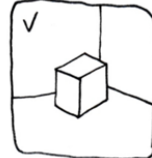
CLEAN THE SPACE	NO OBJECTS ON TOP	YES
		
Avoid having too many objects around the element. The picture should be explicit about the object you want to show.	Don't leave any other elements attached/on top of your element.	

c. Context

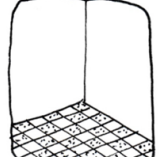
IN ITS CONTEXT	SET OF ELEMENTS
	
Provide an overview of the context in which the element has been installed. It can provide suggestions on how to reuse it afterwards.	If the element belongs to an ensemble, take a picture that displays this (e.g. patterns of tiles)



3. The picture

For most elements, 3 to 5 pictures are generally enough to present their main characteristics. More pictures do not necessarily convey more relevant information. On the contrary, they can complicate the post-processing work. More complex elements, however, may require more pictures to be fully understood.

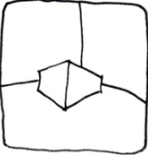
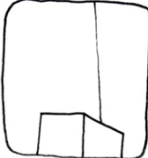
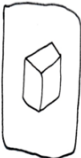
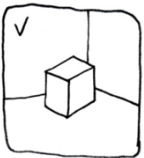

a. Shooting angles

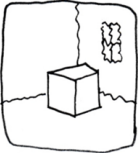
NO FISH EYE	SEE ALL	DON'T STRETCH	YES
			
Avoid using macro lenses. It completely deforms the perception of the element.	Show the whole element. Avoid cutting parts of it (for the main picture at least).	Don't stretch/enlarge the picture when editing it.	



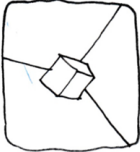
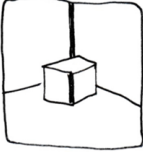

b. Focus

YES	NO
	
Focus on the object and not around it.	

c. Straight picture

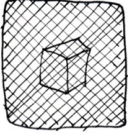
NO OBLIQUE ANGLE	VERTICAL / FRAME	HORIZONTAL / FRAME
		
Shoot the element straight.	Tip 1: align one vertical line with your frame.	Tip 2: align one horizontal line with your frame.

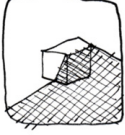
d. Lighting

TOO DARK	NO FLASH	TOO CONTRASTED	BRING A LAMP
			
If possible, shoot the element in the daylight or in a bright room.	Avoid using a flash in the dark.	Use even lighting: too much contrast can disturb the comprehension of the element.	Bring a good lamp with you to shoot the elements in the dark.

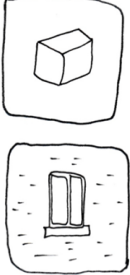
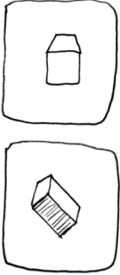
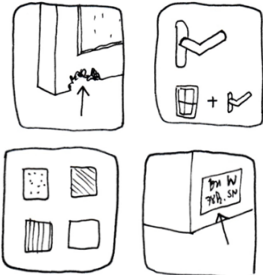

e. Main picture

MAIN PICTURE	ADDITIONAL PICTURES	
		
The main picture aims to summarise the element identified as reusable. It will be used as a thumbnail in the inventory. Therefore, it should be as explicit as possible.	Additional pictures can be used to show more details: the element from different angles, specific information, etc.	Examples of detailed information: traces of wear and tear, complementary elements, technical data, variants of the same product, etc.

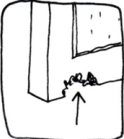

4. Additional information

For some particular elements, additional information should appear in the pictures.

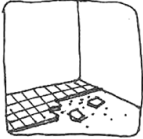
a. Details

MOUNTING PARTS	CLOSE UP	ASSOCIATED ELEMENTS	THE DISMANTLING
			
Show the fixing/ mounting parts of the element.	Show particularities such as defects, small details, traces of wear and tear.	If needed, also shoot the associated elements (door handle, support brackets, etc.).	If you have the opportunity to do so, it is often useful to take pictures of the dismantling (be it a simple test or the actual dismantling operation). It provides information about the way elements are fixed together.

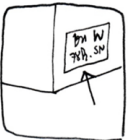
b. Technical data

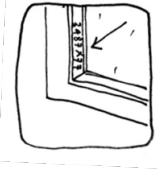
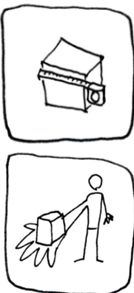
			
For technical equipment, shoot the labels that display information such as: <ul style="list-style-type: none"> • The brand • The serial number (useful for further desk-based research) • Technical performance (speed, power, size, weight, etc.) • The presence of hazardous substances or components 	Show what kind of accessories are needed or parts of the element that are relevant (type of bulb...).	On some elements, technical data can be tricky to find. For windows and glass, for example, look at the interior edge of the glazing.	Take a picture with a benchmark to assess its size (a metre, a person, a hand, a standard object). These pictures will complement other aspects audited during the site visit (diameter of pipes, etc.).

Examples

PARQUET



TILES



SINK



WARM AIR BLOWER



LUMINARIES + FIXATION RAIL

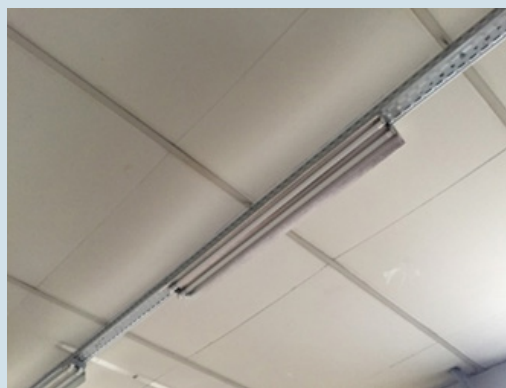

Annex 6: Hazardous substances³³

Historically, some hazardous substances and materials which can impact human health and be toxic for the ecosystem, were used in the building process and building products due to their particular technical properties³⁴. Since then, their hazardousness (to humans and the environment) has been identified.

During dismantling operations, attention must be paid to these dangerous and hazardous substances.

Identification of these substances will allow them to be carefully sorted and treated.

Although it is not recommended, a reclamation audit may be pursued without this preliminary study in the event of time constraints or simply to perform an initial quick screening of the potential of reclaimed materials. Ideally, the hazardousness of all elements is confirmed through the actual audit.

Because rules apply to the identification and manipulation of contaminated materials, specific knowledge is needed to identify the hazardous materials (and their degree of contamination) but also to plan and execute dismantling, sorting, transporting and sanitation operations and taking adequate precautionary measures for the protection of people. Specialised literature, guidelines and legislation underline that it is essential for the assessment to be conducted by **independent and qualified experts**.

This annex provides an initial guideline on how to deal with hazardous products and materials in a building when a reclamation audit is carried out.

Type of contamination

Contamination by hazardous substances can originate from different sources:

- **Related to the material itself or to the connecting elements.**
They can be directly contained in the construction material or can originate from the construction process or treatments carried out during installation.
These include asbestos, man-made mineral fibres (MMMF), polychlorinated biphenyls (PCBs), heavy metals (mercury, lead, chromium,...), polycyclic aromatic hydrocarbons (PAHs), volatile organic compounds (VOCs), organic halogen compounds, organophosphate flame retardants (OPFRs), brominated flame retardants (BFRs), biocides (contained in wood preservatives), etc.
- **A sound material can also be contaminated by another secondary pollutant** (external source): for example, a wood-based material such as parquet can be contaminated by the emanation of PCBs from a contaminated putty, tar or asbestos containing glue might have been used to fix certain elements, etc.
- **Related to the environment and the use** (related to the use and life cycle of the building): use/spillage of mineral oil, solvents and cleaning agents. Biological hazards (such as mould) can also be common in older buildings.

33 *Hazardous substances* should be identified and treated by experts. They cannot be reused. In some cases, and given the right working conditions, *polluting substances* can be removed to ensure the reuse of a product.

34 Which does not exclude the possibility that some hazardous substances can still be used in some current practices.

An inventory focused on hazardous substances

The assessment method to evaluate the presence of contaminants in a building includes several steps.

1. Historical, desk study: analysis of the building and its use. The expert must be attentive to the type and history of the building (function of rooms) and the site where it is located.
 - Possible sources for this study are notably:
 - Plans and technical drawings
 - Construction, refurbishment, renovation, maintenance and sanitation documents
 - Pictures
 - Legal documentation and permits (asbestos survey, soil analysis reports, environmental permits, etc.)
 - Documents from the municipal authorities, etc.
2. Visit of the building: Comparison with existing documents to confirm or rule out any suspicion that may have arisen: examination of actual presence of contaminants and determination of presence of hazardous substances that were not detected during the historic study.

If in doubt

3. Sampling and analysis: If doubts are confirmed or still present, samples should be taken for further analysis in a laboratory.
4. Interpretation of results.

Most common polluting and hazardous substances³⁵

- **Asbestos:** This substance was commonly used in many buildings in various forms because of its good thermal and chemical properties. More than 3700 different applications are known, including sprayed coating or fibro-cement panels. An overview of these applications is therefore impossible to provide. However, buildings constructed (or renovated) after 1998 (in Belgium) do not contain any asbestos materials/products as a result of legislation. While it is the most common contaminant found in buildings³⁶, it is also the most regulated. Specific surveys³⁷ are entirely dedicated to its assessment and removal.
- **Heavy metals:** Such as arsenic (As), cadmium (Cd), chromium (Cr), copper (Cu), mercury (Hg), nickel (Ni), lead (Pb) and zinc (Zn) are mainly present as pigments in paint or lacquer applied on plaster, metal or wood surfaces.
 - Lead-based paint and coatings were commonly used in buildings until 1948 when their use by professionals was banned.

35 The list below is not an extensive overview of the possible types of polluting and hazardous materials in a building.

36 In Flanders, official assessments show that more than 90% of the deconstructed buildings contain asbestos.

37 See main text: Chapter 1, Asbestos survey

- **Polycyclic aromatic hydrocarbon (PAHs):** These are created by heating organic materials in an oxygen-poor environment. These appear mainly in tarred products but can also occur due to fire. PAHs can occur as primary contaminants (asphalt, roofing, pipe liners, etc) or as secondary contaminants (through direct contact, for example).
- **Mineral oil:** This is especially dangerous for the environment. Mineral oil contamination is mainly found near leaking tanks (storage area) or when those oils were used for technical applications (engines or machinery).
- **Polychlorinated biphenyls (PCBs):** These have a wide range of applications. They are cheap and provide good electrical and thermal insulation. They were used notably in applications such as sealants, paints or adhesives. They can also contaminate safe products by evaporation or absorption.

→ Several **lists and documents on polluting and hazardous substances and where to commonly find them in buildings** can be found in literature. These lists should be used with precaution as these are neither complete nor precise enough to be used without expertise. These can, nonetheless, be used for a first walk through of the building to assess reuse potential of construction materials and products.

		Topics	Link
US	EN	List of products and their environmental and health concerns (health hazards, safety risks)	https://www.chicago.gov/content/dam/city/depts/doe/general/GreenBldsRoofsHomes/GreenRemodeling_SalvageReuse.pdf
LUX	FR	Type of contaminants and where to find them in a building	https://environnement.public.lu/fr/actualites/2018/07/iventaire-materiaux.html
BE	FR/NL	Type of products, where they are to be found and their possible contaminations	https://www.cstc.be/homepage/index.cfm?cat=publications&sub=search&id=CSTC84125

Guidelines for reclamation audits started before a hazardous substances study

- It is always better to conduct the reclamation audit after an asbestos and hazardous substances study to avoid any risk.
- In any case, no dismantling operation or destructive test should be carried out without an assessment on the presence of asbestos (although a reclamation auditor could still make a preliminary visual assessment of the reuse potential).
 - NB: in most countries, it is a legal requirement to have an asbestos inventory of an existing building performed (even if it's not going to be demolished), more specifically when people are working in the building, nearby or possibly in contact with asbestos.
- In some countries or regions, a construction and/or environmental permit is mandatory and regulated before demolition takes place. This procedure sometimes has certain specifications in terms of asbestos and other hazardous contaminants.

- **“Better safe than sorry”, be very aware of your own responsibility and the consequences of incorrect identification and reuse.** What might be identified as ‘safe’ in an initial quick scan could be marked as dangerous following a consultation and assessment by the expert.

Practical tools for the identification of hazardous products (incl. language)

The summary of links to official websites listed below will provide more information or background on different hazardous substances which can be found in or outside the building³⁸.

		Topics	Link
BE	NL	Asbestos, lead, insects, toxic substances, fungus etc.	http://www.gezondheidenmilieu.be/nl/subthemas-4.html
BE	NL/ FR/DE	Asbestos	http://alertvoorasbest.be/ http://solutionspourlamiante.be/
BE	NL	Asbestos	https://www.ovam.be/omgaan-met-asbest
BE	NL/FR	Asbestos	https://www.belgium.be/fr/sante/vie_saine/habitat/amiante https://www.belgium.be/nl/gezondheid/gezond_leven/woonomgeving/asbest
BE	NL/FR	Dangerous waste	https://environnement.brussels/thematiques/batiment/la-gestion-de-mon-batiment/les-chantiers/les-dechets-de-chantier-les-3
BE	NL/FR	Identification of asbestos, where is it usually found	Les Dossiers du CSTC – Cahier n°7 – 2e trimestre 2005, Identification de l’amiante dans le bâtiment: https://www.cstc.be/homepage/index.cfm?cat=publications&sub=search&id=CSTC75748
UK	EN	Lead paint	www.gov.uk/government/publications/advice-on-lead-paint-in-older-homes

38 In addition to the ones listed above.

Annex 7: Further Reading

Publications

B. ADDIS, *Building with Reclaimed Components and Materials. A Design Handbook for Reuse and Recycling*. London: Sterling, VA: Earthscan, 2006.

Bellastock (J. BENOIT, G. SAUREL, S. HALLAIS). *REPAR. Réemploi comme passerelle entre architecture et industrie*. 2012-2014. Report nr. 12 06 C0069, ADEME, 2014.

Bellastock (J. BENOIT, G. SAUREL, M. BILLET), CSTB (S. LAURENCEAU, F. BOUGRAIN). *REPAR #2. Le réemploi passerelle entre architecture et industrie*. Report nr. 1406C0043, ADEME, 2018.

Centre Scientifique et Technique du Bâtiment, Circolab. *Fiche méthodologie/process diagnostic pour réemploi des produits de construction*, 2018.

CIFFUL (J-M. GUILLEMEAU, P. WEGELMANS, J. WAGELMANS), RESSOURCES asbl (B. JANSSENS, C. PATRIS), CCW (A-S. HALLET, A. ARGELES), *Guide Pratique sur le réemploi/réutilisation des matériaux de construction*, Liège : Editions de l'Université de Liège, 2013

Chicago Department of Environment, *Green home remodelling series, healthy homes for a healthy environment, Salvage & reuse*, October 2007

CSTC (A. ROMNÉE, J. VRIJDERS). *Vers une économie circulaire dans la construction. Introduction aux principes de l'économie circulaire dans le secteur de la construction*. CSTC : Monographie n° 28, 2018.

Deconstruction institute (B. GUY, E. M. GIBEAU) , *A Guide to deconstruction*, Florida, 2003.

RDC Environment, éco BTP, I Care & Consult. *Identification des freins et des leviers au réemploi de produits de construction.*, Report for ADEME, 2016.

Recovering, Occamat, UPM –: *GtoG project – DB2: European handbook on best practices in audit prior to deconstruction of buildings*, 2015

A. ROMNÉE, L. PÉREZ DUÑAS, C. BOYER, P. VAN GINDERDEUREN. *Le secteur de la construction à Bruxelles. Constat et perspectives : vers une économie circulaire*. Brussels : Bruxelles-Environnement. 2018.

Rotor (S. SEYS, L. BILLIET). *Vade-mecum pour le réemploi hors-site. Comment extraire les matériaux réutilisables de bâtiments publics*, Brussels, 2015.

Rotor (M. GHYOOT), *Objectif réemploi. Pistes d'actions pour développer le secteur du réemploi en Région de Bruxelles-Capitale*, As part of the ERDF-research project Le Bâti bruxellois, source de nouveaux matériaux (BBSM), Brussels, 2017.

Rotor (M. GHYOOT, L. DEVLIEGER, L. BILLIET, A. WARNIER), *Déconstruction et réemploi. Comment faire circuler les éléments de construction*, Lausanne : Presses Polytechniques et Universitaires Romandes (PPUR), 2018.

The ReUse People of America, Inc., *TRP Certified Deconstruction Contractor Manual. Part 1: Classroom training*. Oakland, 2006.

V. VANKAN, C. DEJERPHANION, "La meccanica del rigiovanimento, Mechanics of rejuvenation", *Inside Quality Design*, September 2019, 100-107

VTT (M. WAHLSTROM, P. HRADIL), Tracimat/VCB (L. VAN CAUWENBERGHE), VITO (J. BERGMANS), *Parade webinar series, Best Practice for Pre-demolition Audits, Webinar 1: 12 September 2019, Role of waste audit in Circular Economy*, September 2019

Waste & Resources Action Programme (WRAP), *Reclaimed building products guide. A guide to procuring reclaimed building products and materials for use in construction projects*, Banbury, Oxon: Waste & Resources Action Programme, 2008.

Online references

Bati Récup' (S. FRUIT, J. POUTAS), *Catalogue de la récupération : Archipel Habitat opération réemploi : 1,3,5 et 18 de la rue Marbaudais*, 2018, < <https://www.batirecup.com/operation-reemploi> >

'Be Circular be brussels', *Be Circular be brussels*, <<http://www.circulareconomy.brussels>>

Bruxelles Environnement, *Dossier : réemploi-réutilisation des matériaux de construction*, < <https://www.guidebatimentdurable.brussels/fr/reemploi-reutilisation-des-materiaux-de-construction.html?IDC=23&IDD=14539> >

CDR Construction, *Materiauteek*, <<http://materiauteek.brussels/>>

CDR Construction, *Réemploi des matériaux de construction*, < <http://reuse.brussels/>>

Cycle up, *La 1ère plateforme professionnelle de réemploi des matériaux du bâtiment et de l'immobilier*, <<https://www.cycle-up.fr/>>

J. VERDONCK, "Circulaire materialen lopen in kringen, behalve als ze even een rustpauze houden", *De wijk van morgen*, 13 august 2019, < <http://www.dewijkvanmorgen.be/eigen-keuze/channel/1/de-wijk-van-morgen> >

guidebatimentdurable.brussels, portal of Brussels Environment's Sustainable Construction Guide, <<https://www.guidebatimentdurable.brussels/fr/accueil.html?IDC=1506>>

Opalis, *Construire et rénover en réemploi*, <<https://opalis.eu/fr>>

Salvoweb, online directory of reclamation dealers from over forty countries including UK, USA, France, Ireland, Australia, Canada, Germany. It is complemented by a system of dismantling and demolition alerts (mentioned in this report), and other features related to antique, reclaimed or salvaged materials.<<https://www.salvoweb.com/>>

tracimat.be, portal of Flemish non-profit C&D waste management organization.<<http://www.tracimat.be/>>

Uclouvain, Architecture et Climat, CSTC-WTCB, Rotor, VUB, *Le Bati Bruxellois Source de Nouveau Matériaux*, <<https://www.bbsm.brussels/en/home/>>

The Construction index, *The case for pre-demolition audits*, 7 March 2013 <<https://www.theconstructionindex.co.uk/news/view/the-case-for-pre-demolition-audits>>

Legal references and policy framework

European Union

Directive 2008/98/EC of the European Parliament and of the Council of 19 November 2008 on Waste and Repealing Certain Directives.

Directive 2014/24/UE of the European Parliament and of the Council of 26 February 2014 on Public Procurement and Repealing Directive 2004/18/EC.

European Commission, *Guidelines for the waste audits before demolition and renovation works of buildings*, EU Construction and demolition Waste Management, May 2018

European Commission, *Report from the Commission to the European Parliament, the Council, The European Economic and Social Committee and the Committee of the Regions on the Implementation of the Circular Economy Action Plan*, April 2019.

European Council, *Council Conclusions on Circular Economy in the Construction Sector*, 2019.

European Parliament, EPRS, *Closing the loop: New circular economy package*, Briefing, January 2016

European Parliament, EPRS, *Turning waste into a resource - Moving towards a circular economy*, Briefing, December 2014

Belgium

Be Circular - Be.brussels / Bruxelles Environnement, *Feuille de Route Des Acteurs de La Construction à Bruxelles - Vers Une Économie Circulaire*, Brussels : Brussels Environnement, 2019.

Brussels-Capital Region (be.circular), *Programme régional en économie circulaire 2016-2020 (PREC)*, March 2016.

Région de Bruxelles-Capitale, *Programme Régional en Economie Circulaire. 2016-2020. Mobiliser les ressources et minimiser les richesses perdues: pour une économie régionale innovante*. Brussels : Be Circular, 2016

Bruxelles Environnement, *Plan de gestion des ressources et des déchets*. Brussels : Brussels Environment, 2018

Région de Bruxelles-Capitale, *Arrêté du Gouvernement de la Région de Bruxelles-Capitale relative à la gestion des déchets*, Brussels, 2016

France

Décret N° 2016-811 Du 17 Juin 2016 Relatif Au Plan Régional de Prévention et de Gestion Des Déchets, 2016-811, 2016.

Ministère de l'écologie, du développement durable, des transports et du logement, *Arrêté du 19 décembre 2011 relatif au diagnostic portant sur la gestion des déchets issus de la démolition de catégories de bâtiments*, French Government, 2011

Feuille de Route de l'économie Circulaire - 50 Mesures Pour Une Économie 100% Circulaire, 2018.

United-Kingdom

HM Government, *A Green Future: Our 25 Year Plan to Improve the Environment, 2018.*

Infrastructures and Projects Authority, *Government Construction Strategy 2016-2020, 2016.*

UK Parliament, *The Site Waste Management Plans Regulations, London, United Kingdom of Great Britain and Northern Ireland, 2008*